

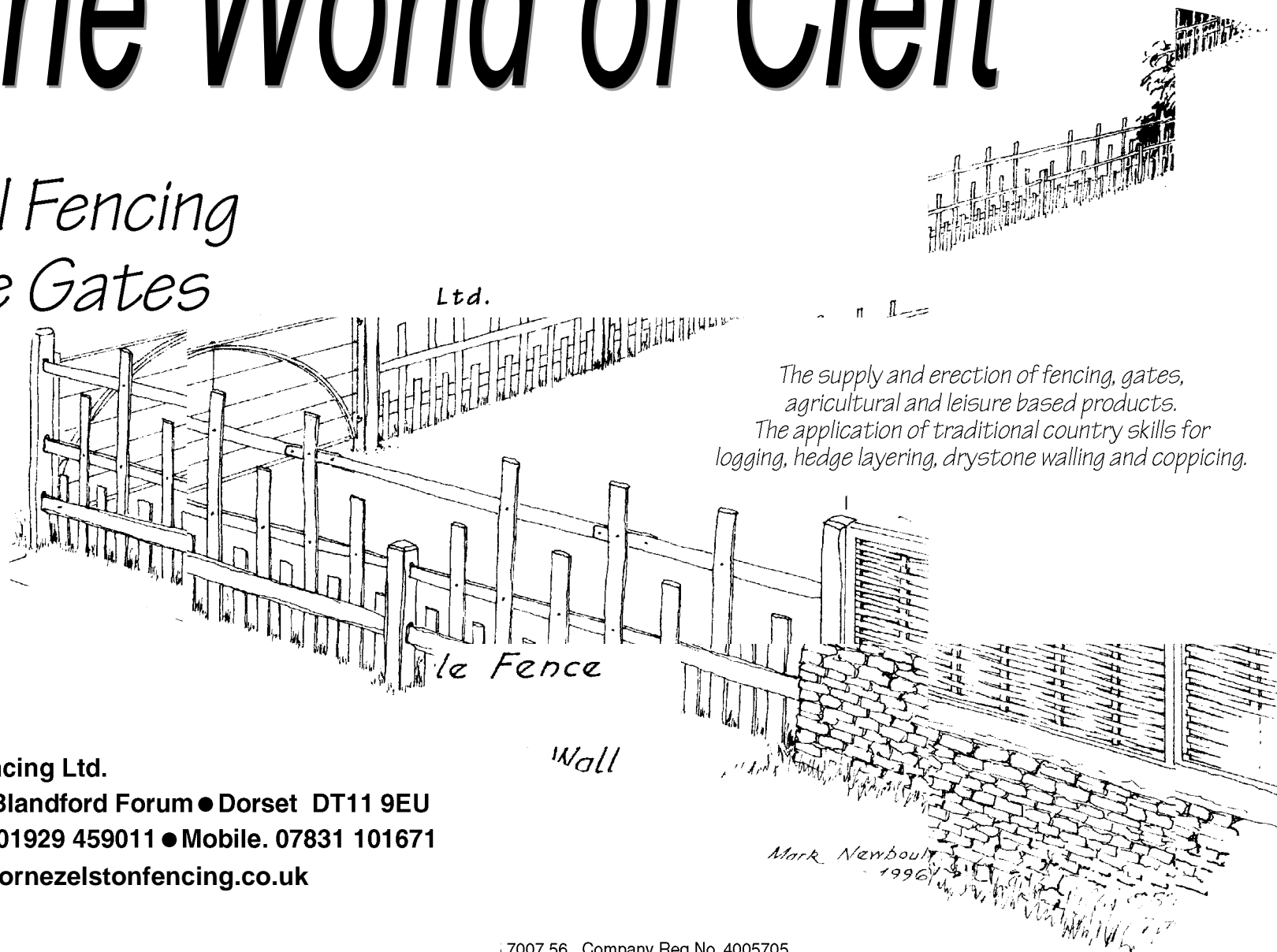

The World of Cleft

*Traditional Fencing
Handmade Gates
and Stiles*



*The supply and erection of fencing, gates,
agricultural and leisure based products.
The application of traditional country skills for
logging, hedge layering, drystone walling and coppicing.*

Winterborne Zelston Fencing Ltd.
Winterborne Zelston • Blandford Forum • Dorset DT11 9EU
Tel. 01929 459245 • Fax. 01929 459011 • Mobile. 07831 101671
Email.: richard@winterbornezelstonfencing.co.uk

Adheres to:
BS EN ISO 9002, 1994.

7007 56 Company Reg No. 4005705

Winterborne Zelston Fencing Ltd.

Tel. 01929 459245

Typical Cattlegrid Scenario



Kissing Gate
with Estate Hurdles

Spargrove Mill Bridge

Shepherd Crook Field Gate
& Cattle Grid
Mark Newbold 1996

Winterborne Zelston Fencing Ltd.

Tel. 01929 459245

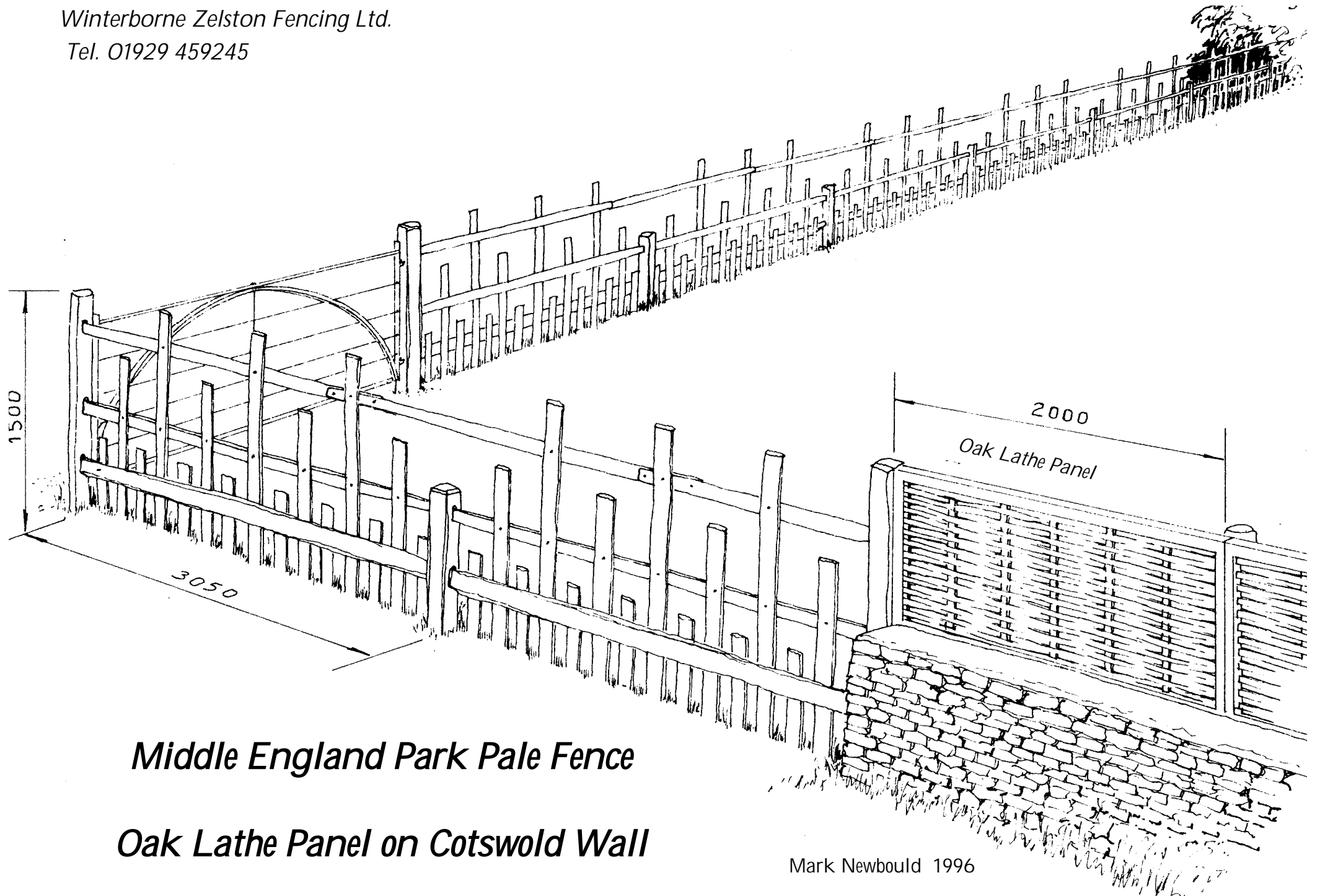

Middle England Park Pale Fence

Oak Lathe Panel on Cotswold Wall

Mark Newbould 1996

Winterborne Zelston Fencing Ltd.

Tel. 01929 459245

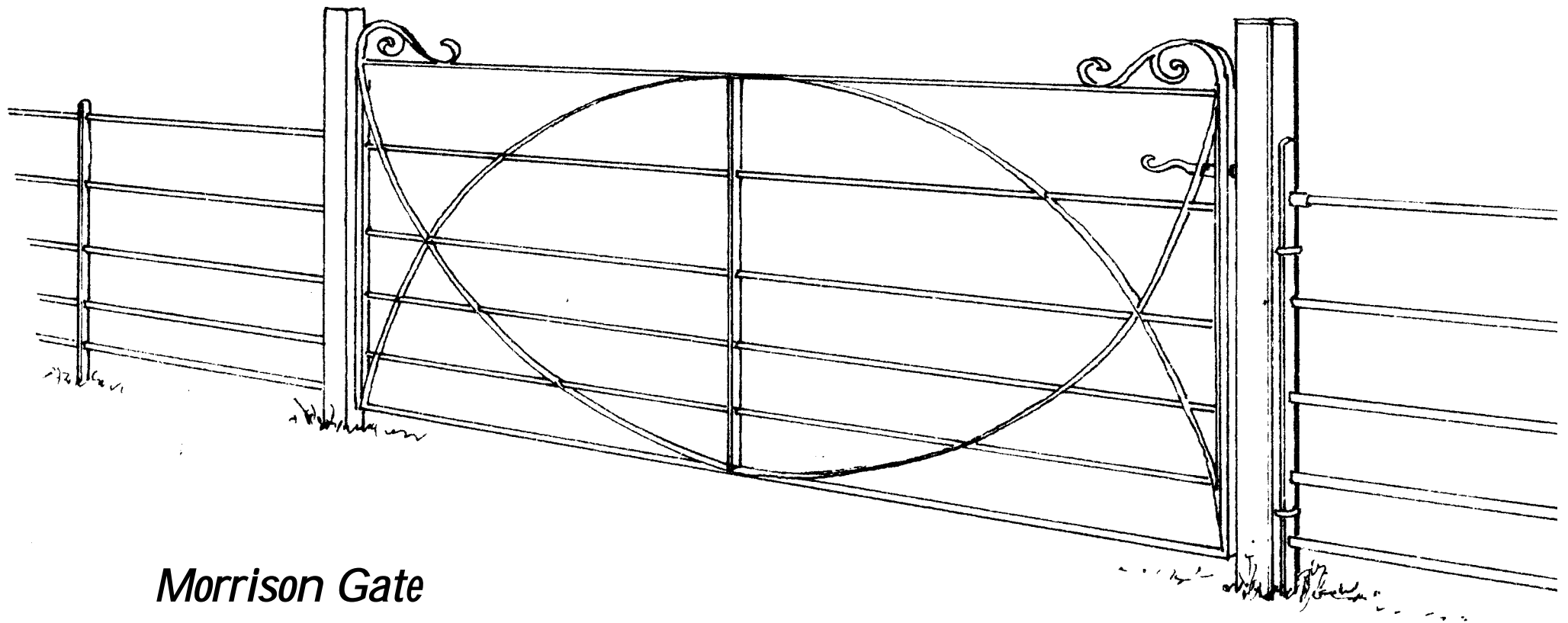

Morrison Gate

Mark Newbold 1996

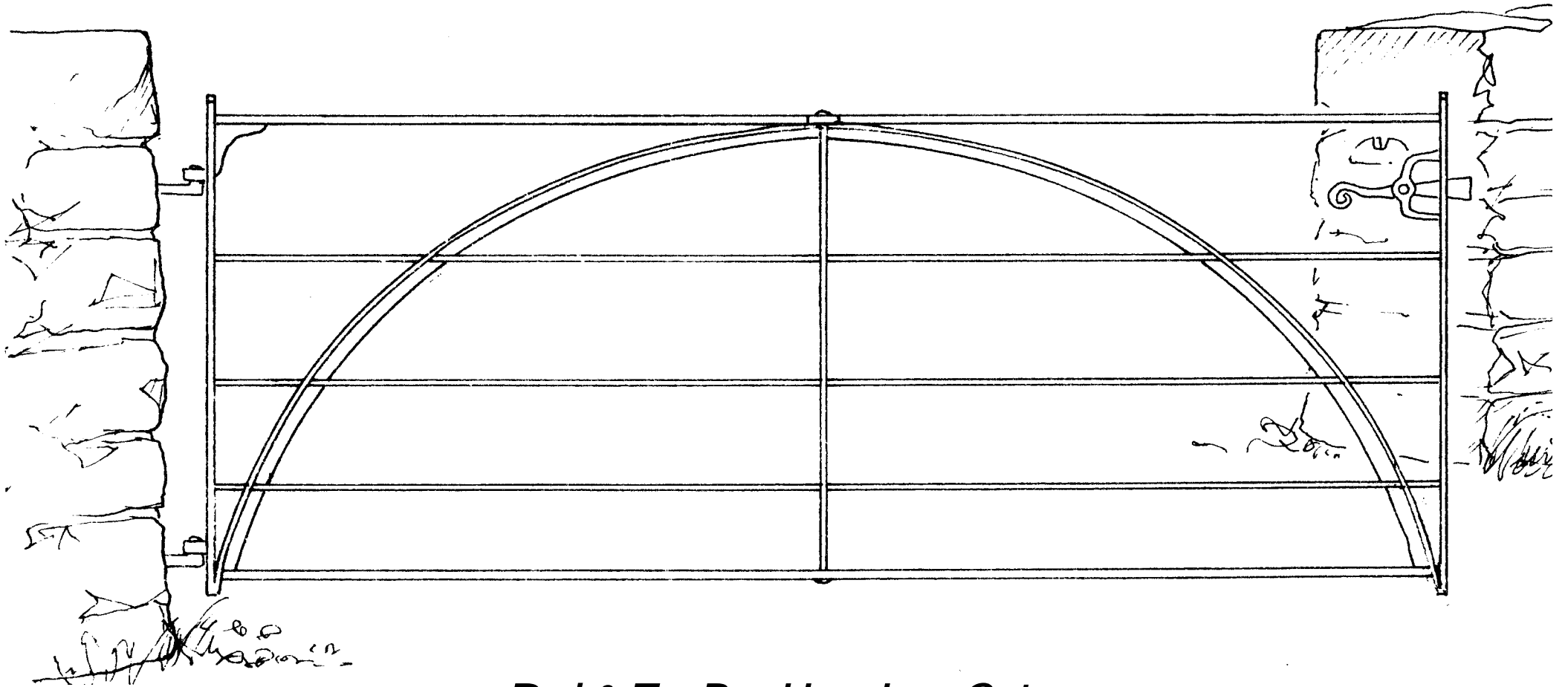

Rod & Tee Bar Hoop Iron Gate
An Elegant Sheep Gate of 18th Century Style

Bar & Hoop Garden Gate

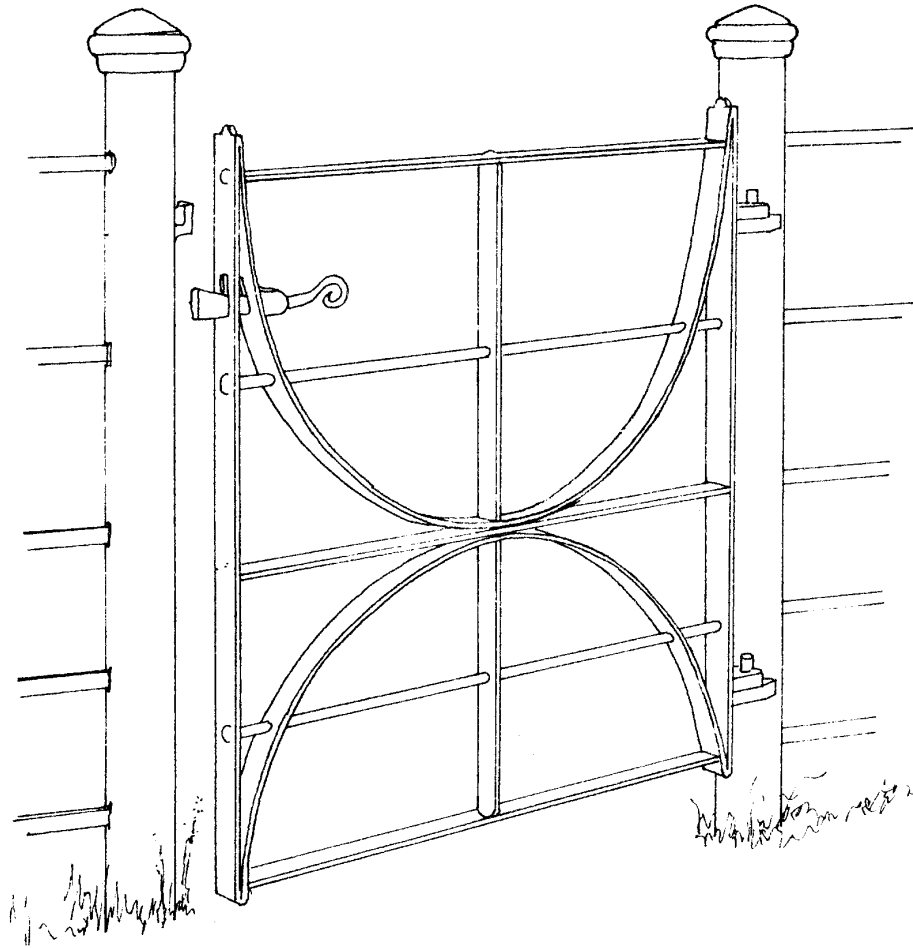

Evercreech Turnstile

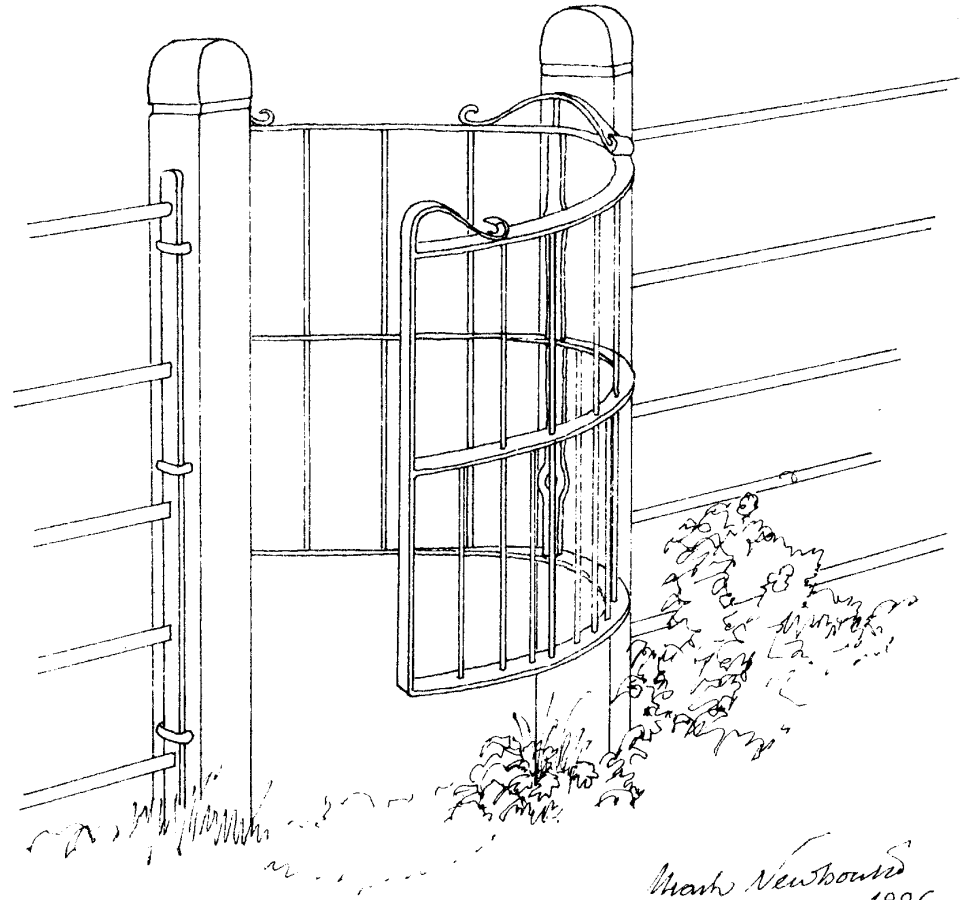

Winterborne Zelston Fencing Ltd.

Tel. 01929 459245

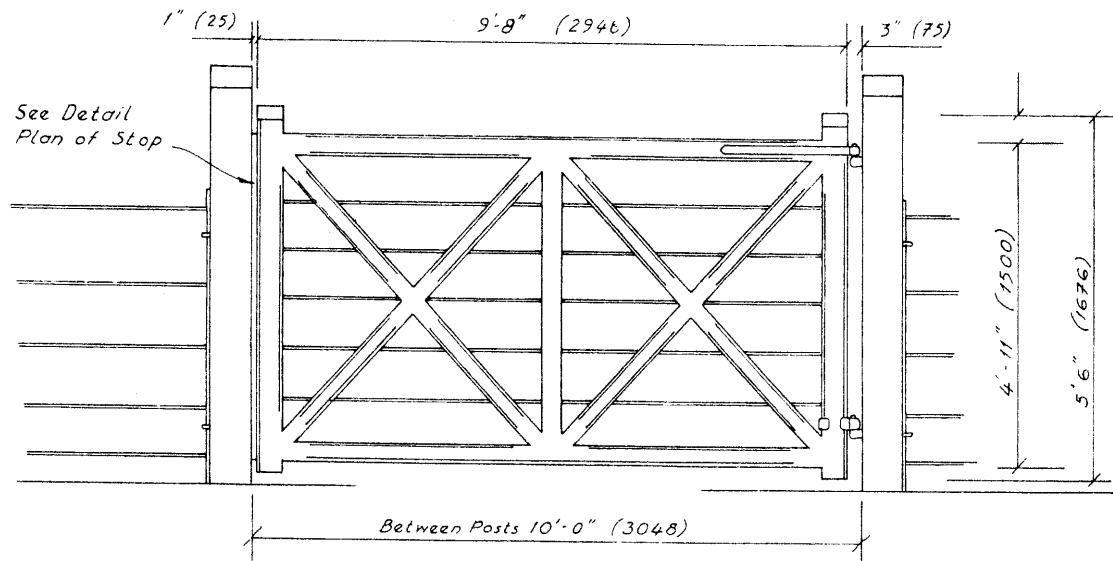
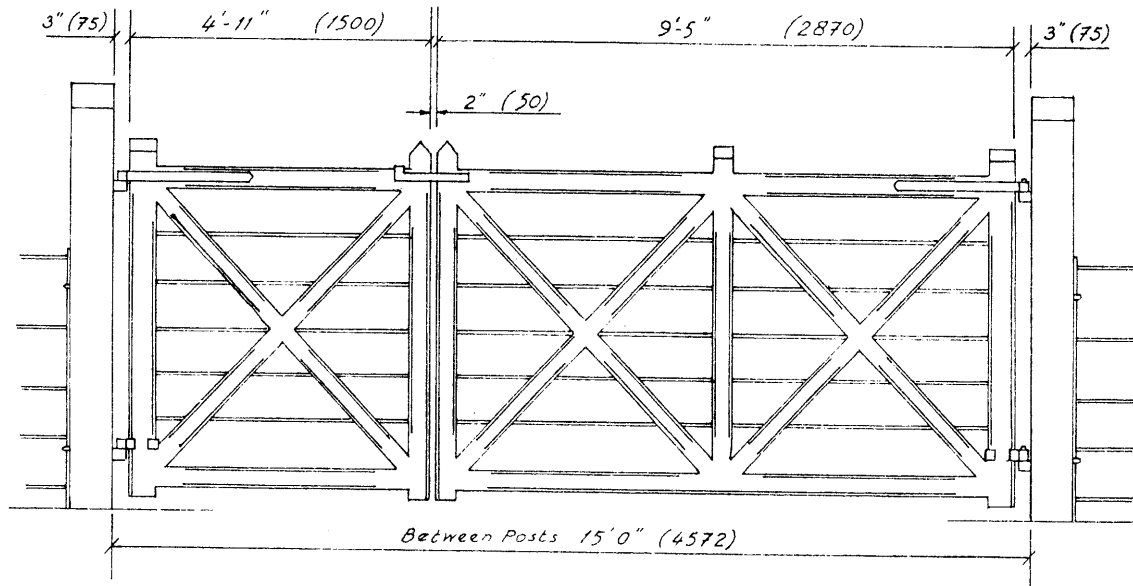

Plan of Stop

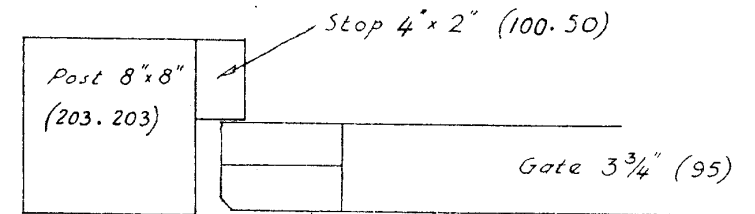

Sarsden Boundry Entrance Gate

M Newbold 1996

Winterborne Zelston Fencing Ltd.

Tel. 01929 459245

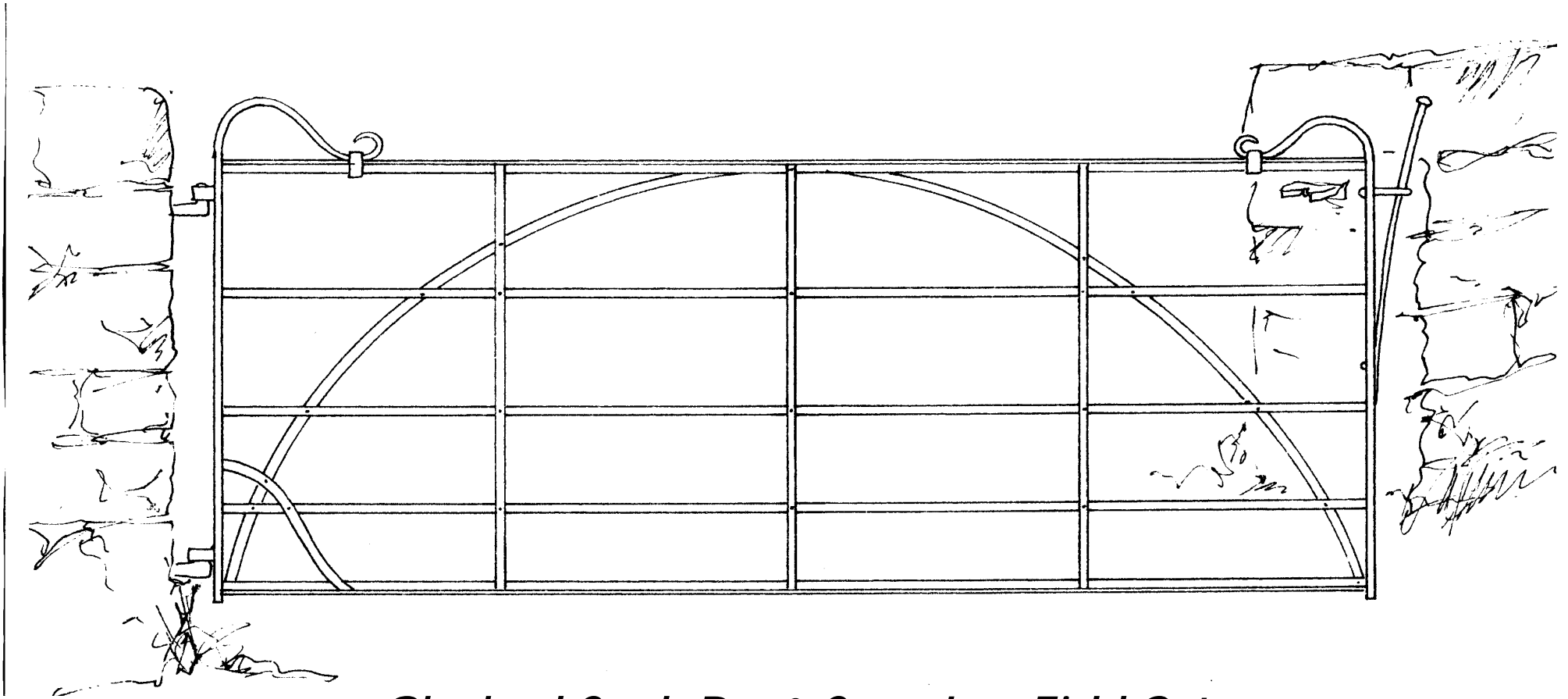

Shepherd Crook Bar & Curve Iron Field Gate

CM Newbold 1996

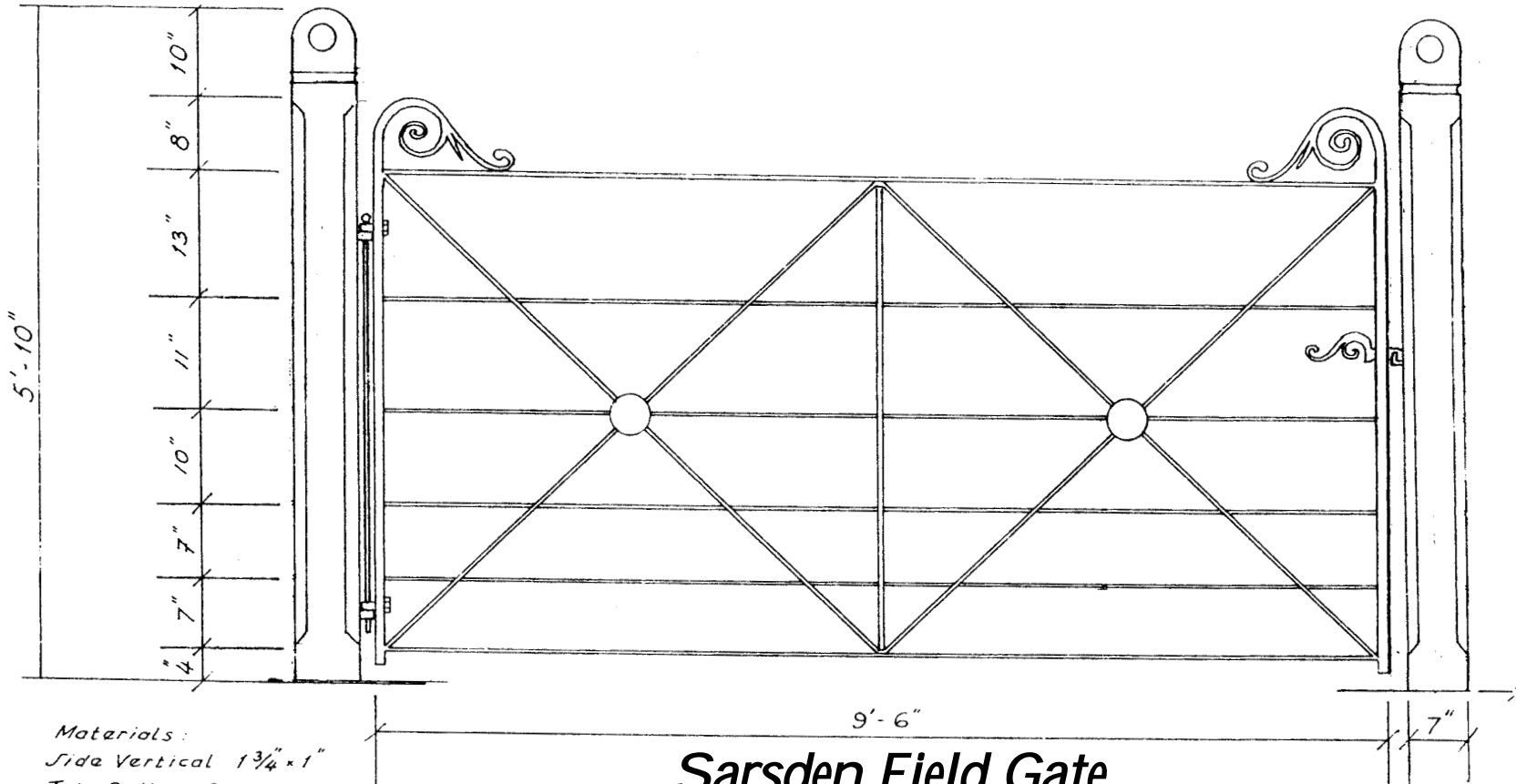

Materials:
Side Vertical $1\frac{3}{4} \times 1$ "
Top, Bottom, Centre,
& Diagonals $1\frac{3}{4} \times \frac{1}{2}$ "
Horizon. Bars $\frac{1}{2}$ " Round.

Sarsden Field Gate

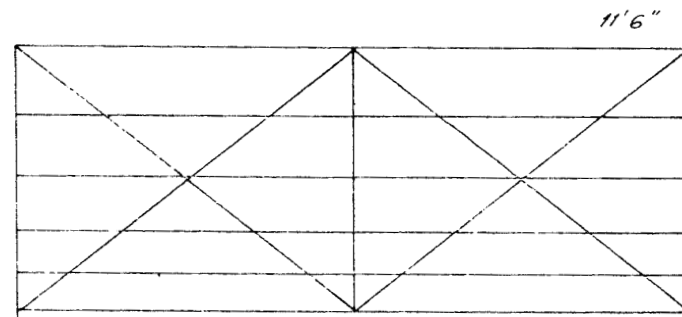
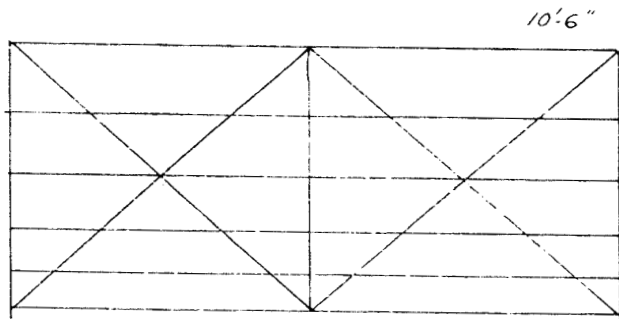

Winterborne Zelston Fencing Ltd.

Tel. 01929 459245

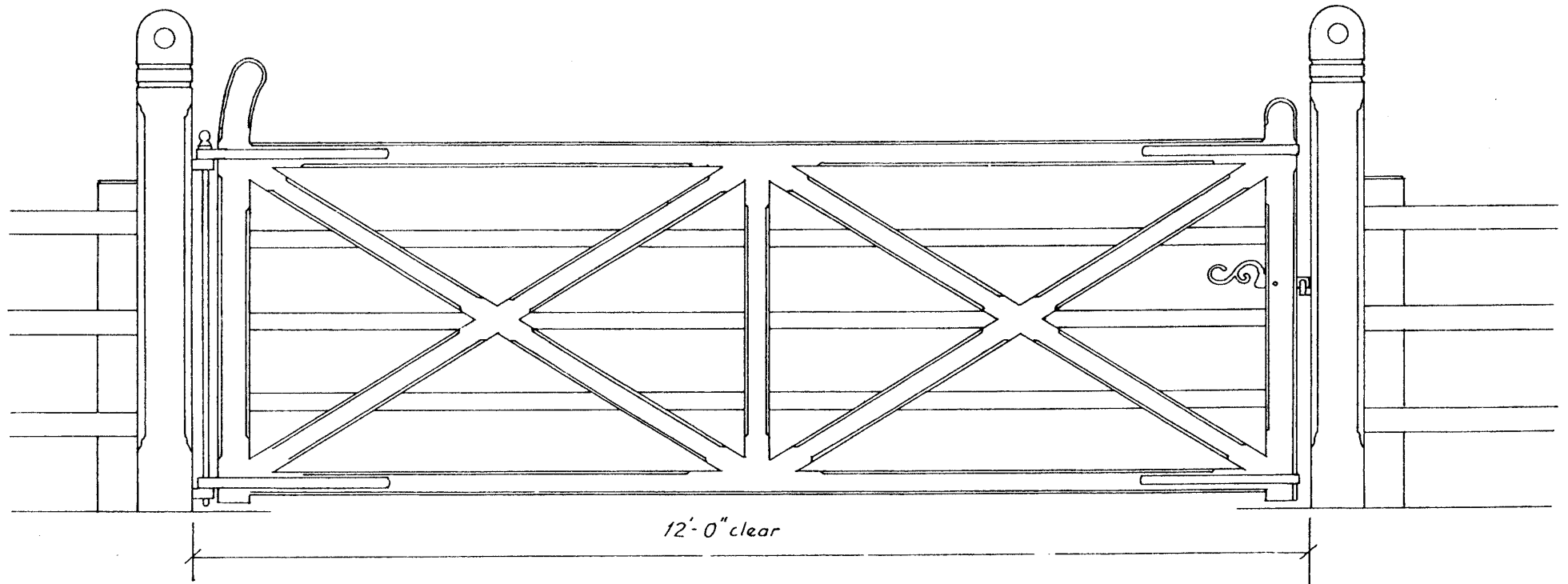

The Meran Gate

M. Newbould del.

C. Nov 95

Meran Gate with Traditional Hanging Set

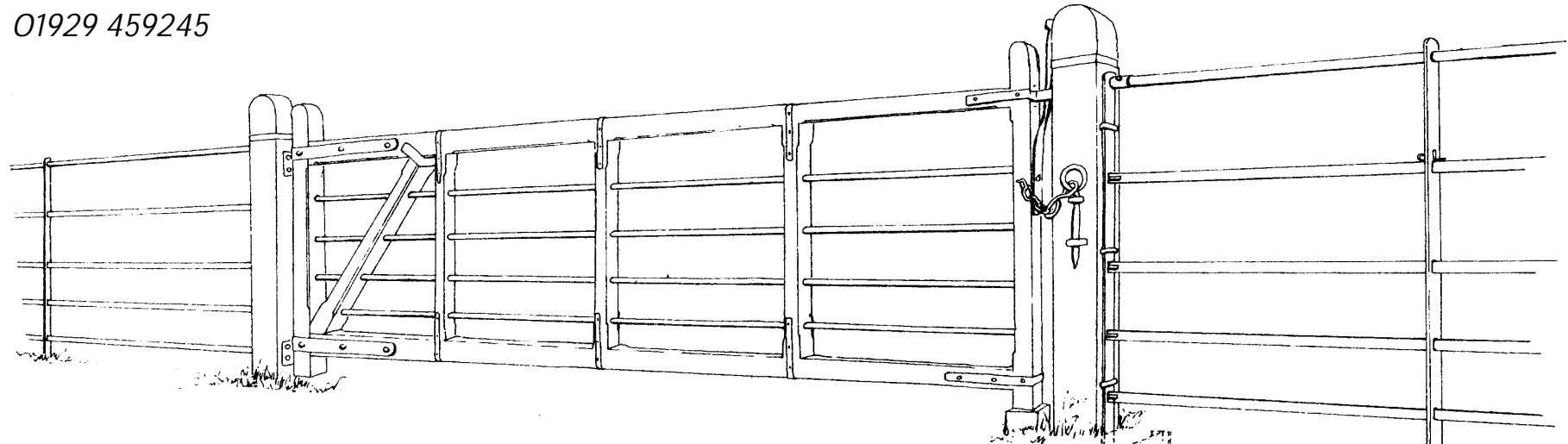

Estate Rod Gate & Railing

Thrust Plate

Pronged Foot

Oak Kissing Gate

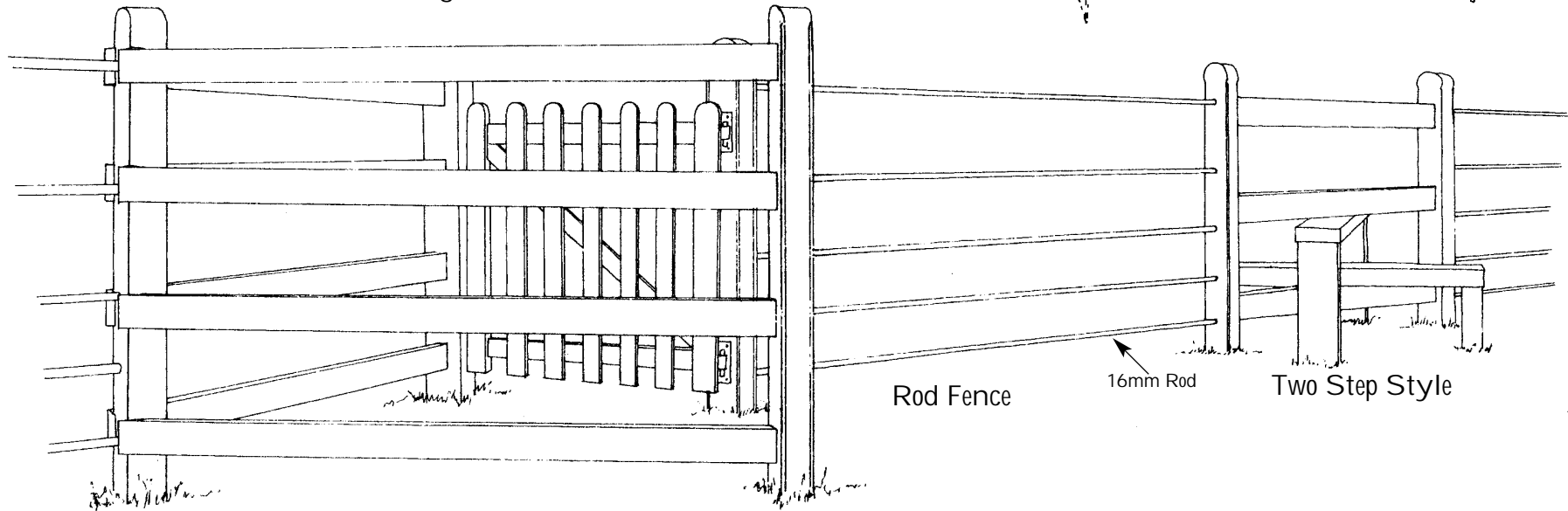

Rod Fence

16mm Rod

Two Step Style

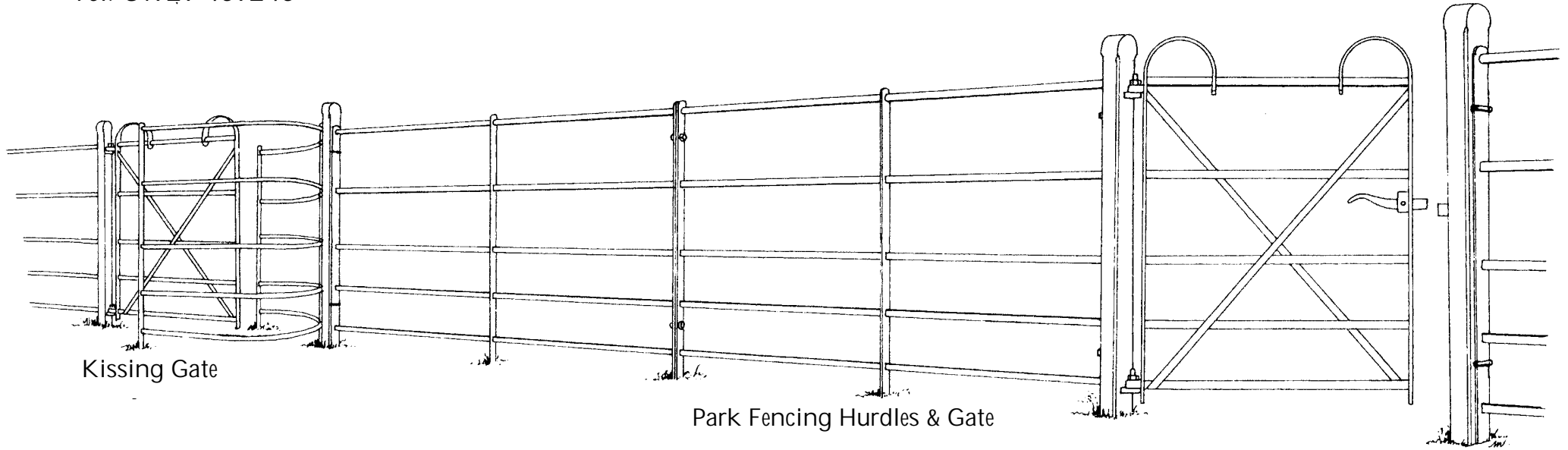

Kissing Gate

Park Fencing Hurdles & Gate

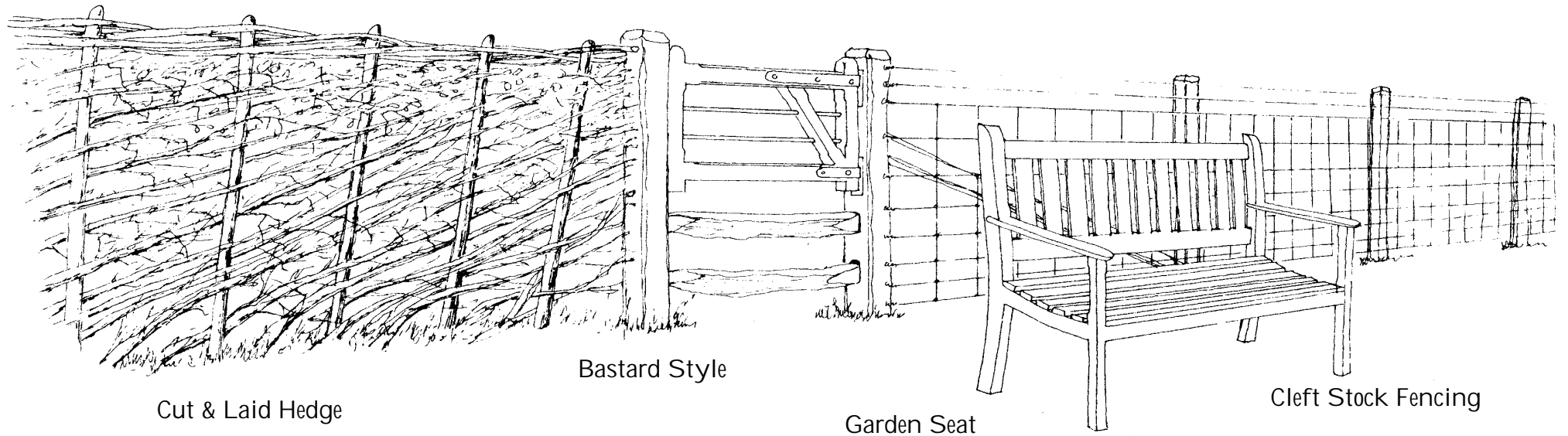

Cut & Laid Hedge

Bastard Style

Garden Seat

Cleft Stock Fencing

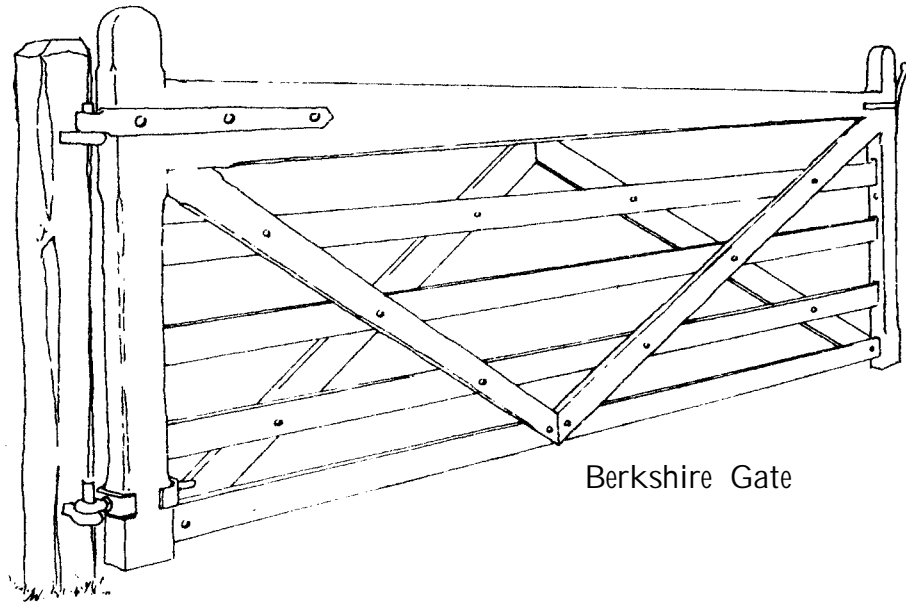

Berkshire Gate

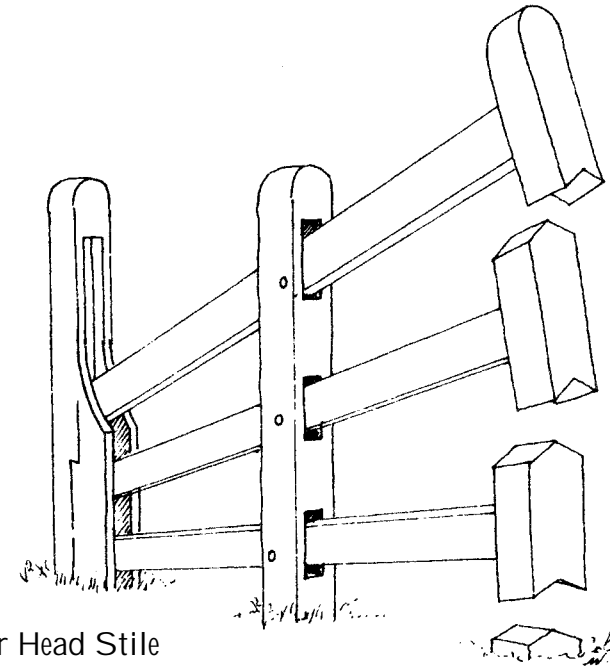

Hammer Head Stile

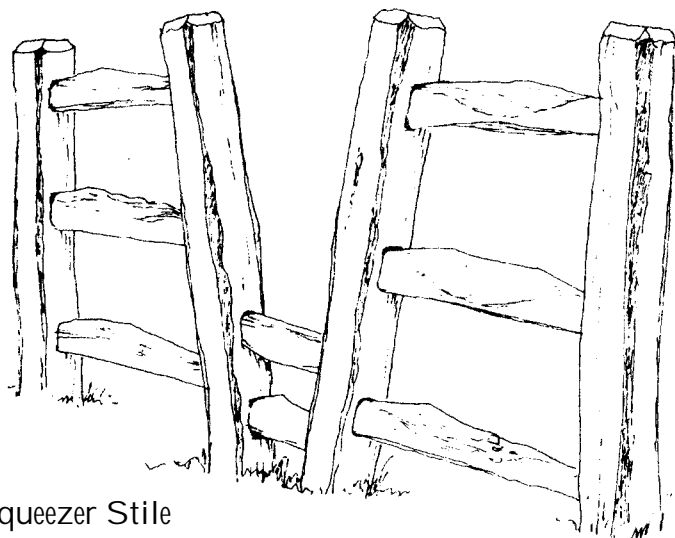

Squeezer Stile

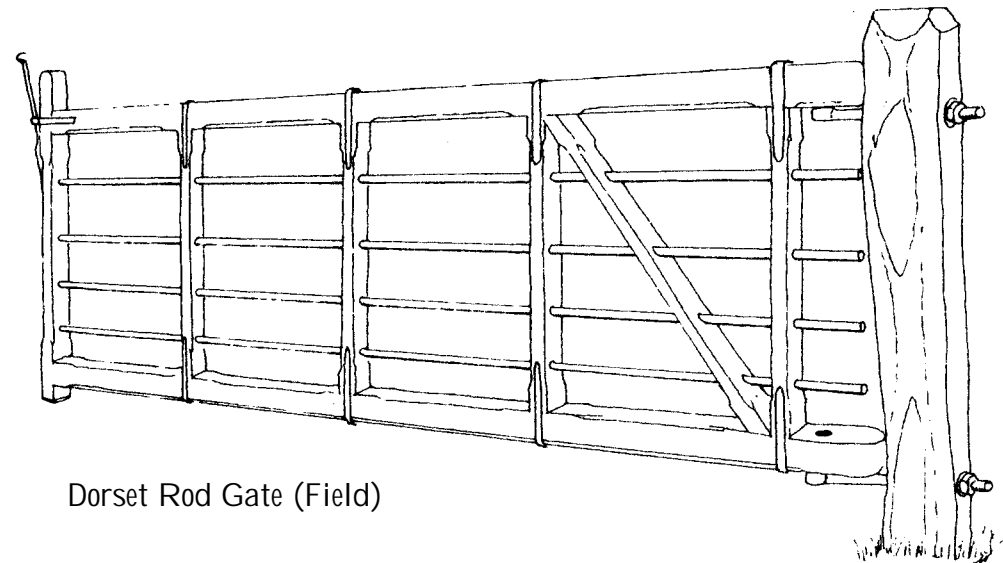

Dorset Rod Gate (Field)

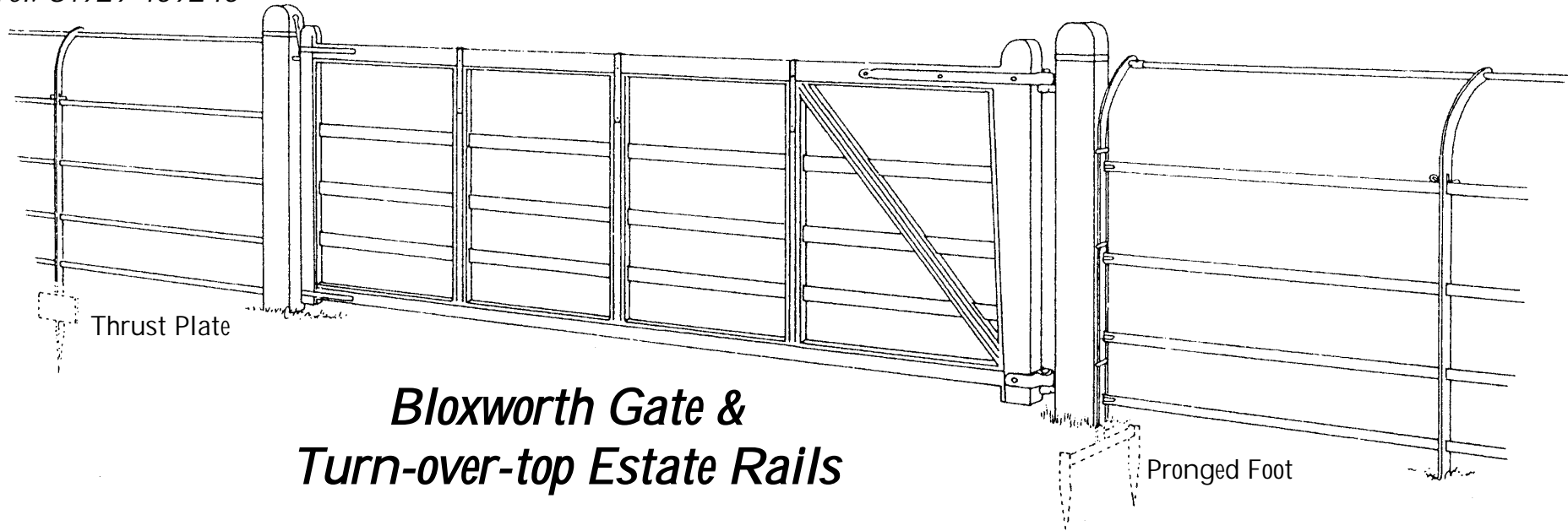

***Bloxworth Gate &
Turn-over-top Estate Rails***

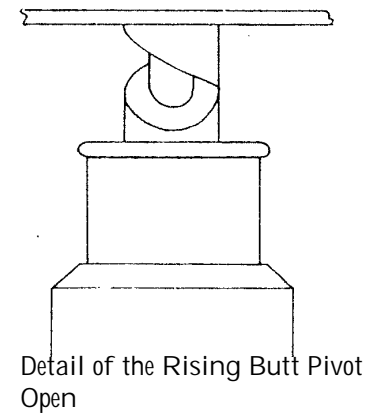
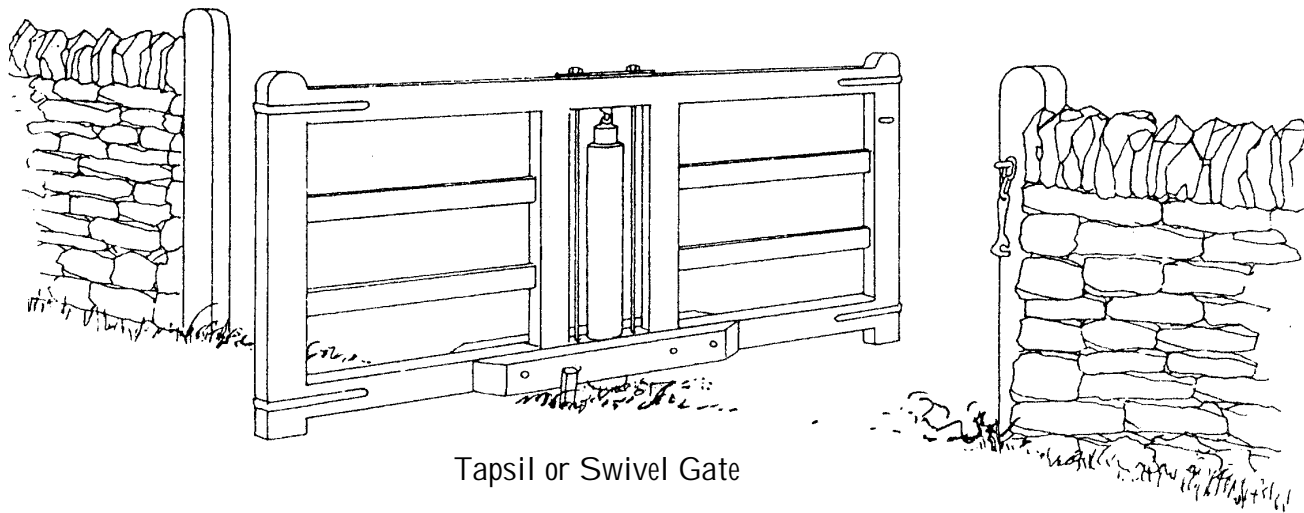

Mark Newbold 1995

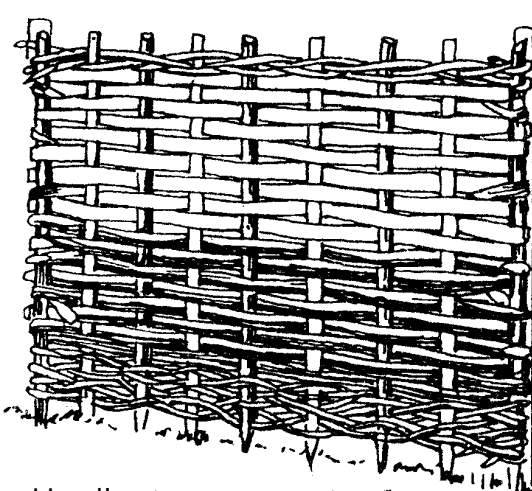

Hurdles (Hazel & Willow)

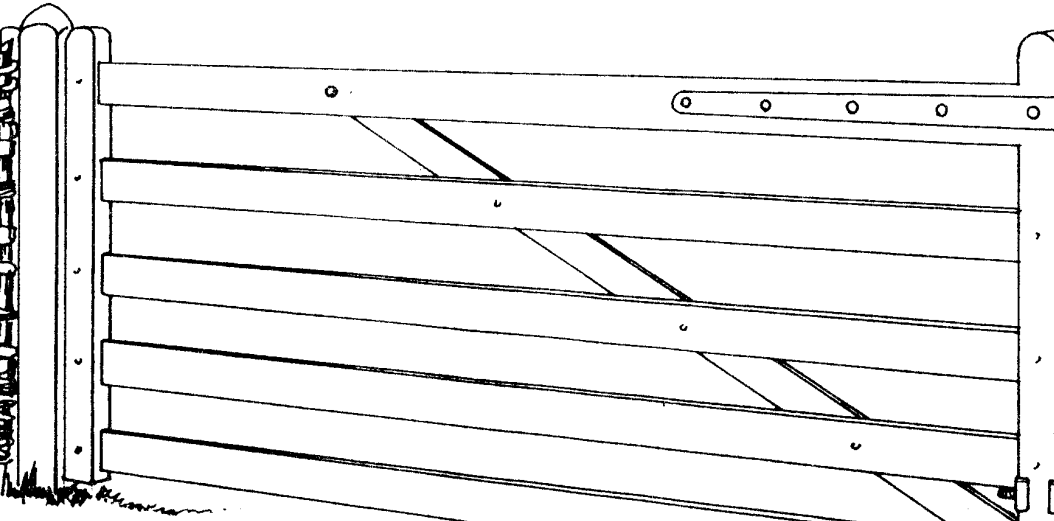

Boatlane or Field Gate

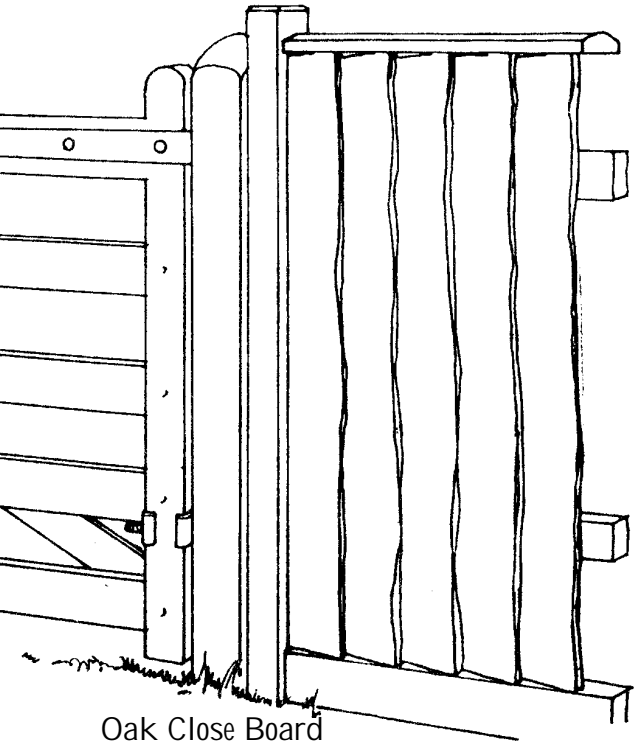

Oak Close Board

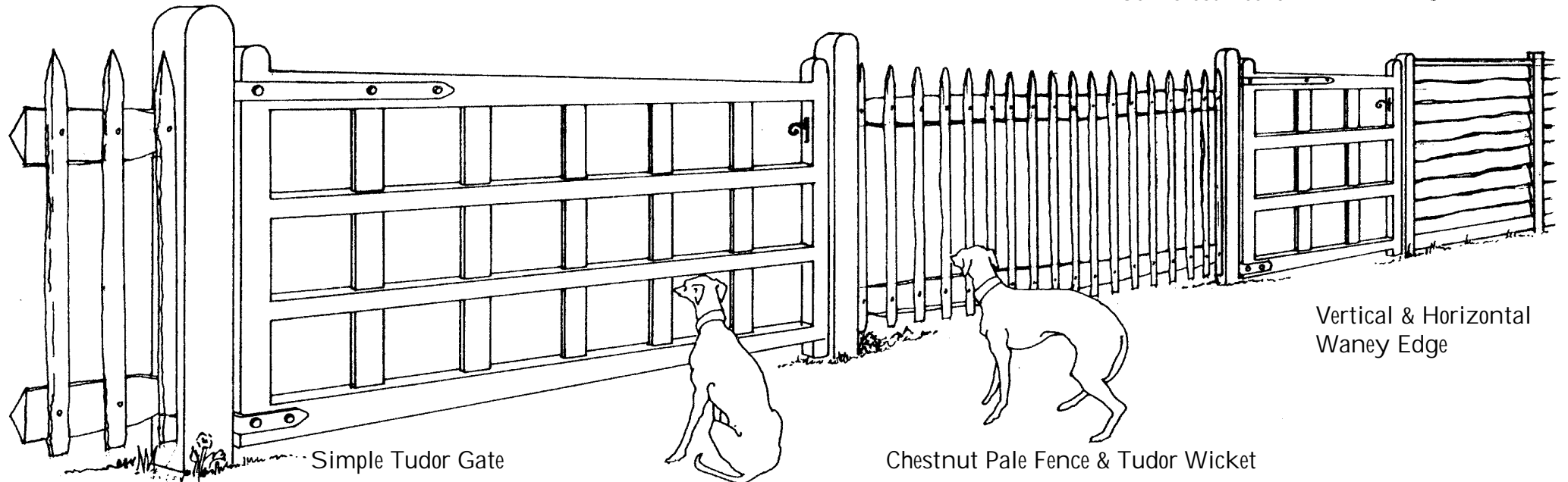

Simple Tudor Gate

Chestnut Pale Fence & Tudor Wicket

Vertical & Horizontal
Waney Edge

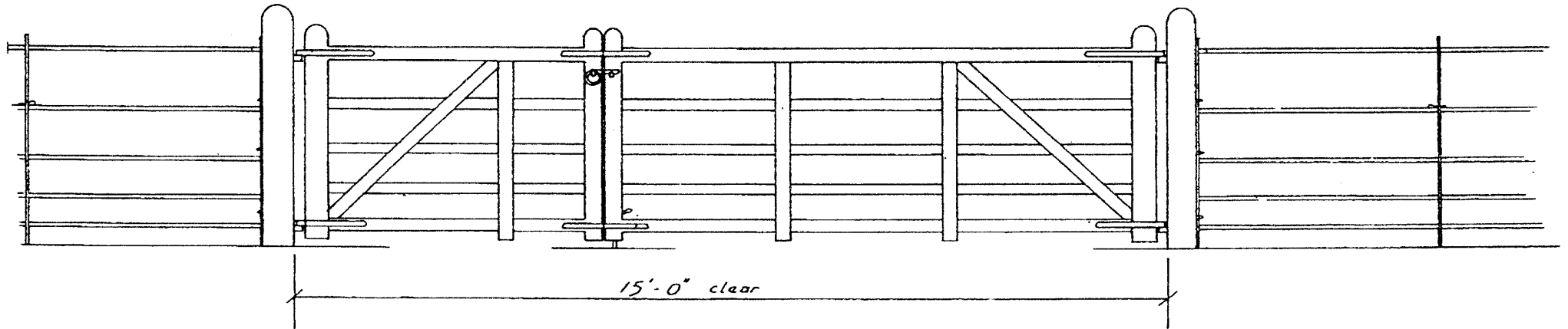

***The Cotswold Gate & Wicket
with Estate Railing***

Winterborne Zelston Fencing Ltd.

Tel. 01929 459245

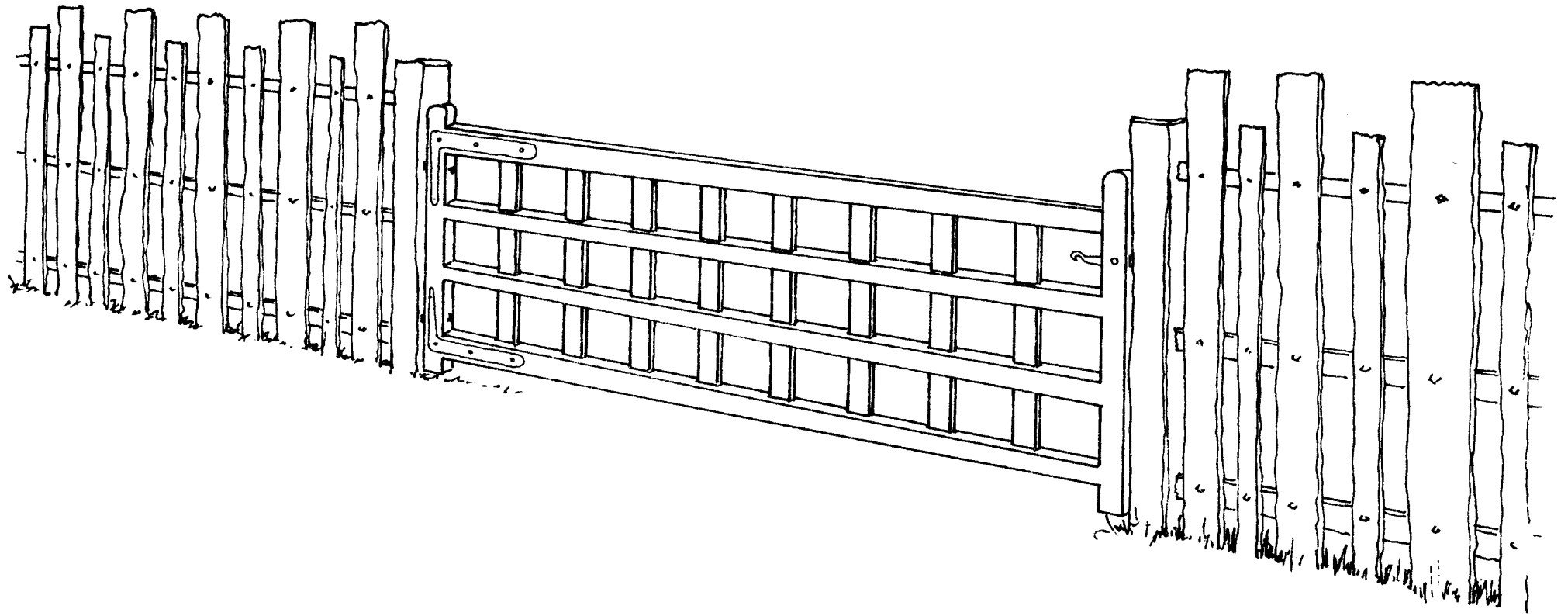

***Norman Park Paling of Cleft Oak
& Tudor Field Gate***

Mark Newbold 1996

Ride Gate

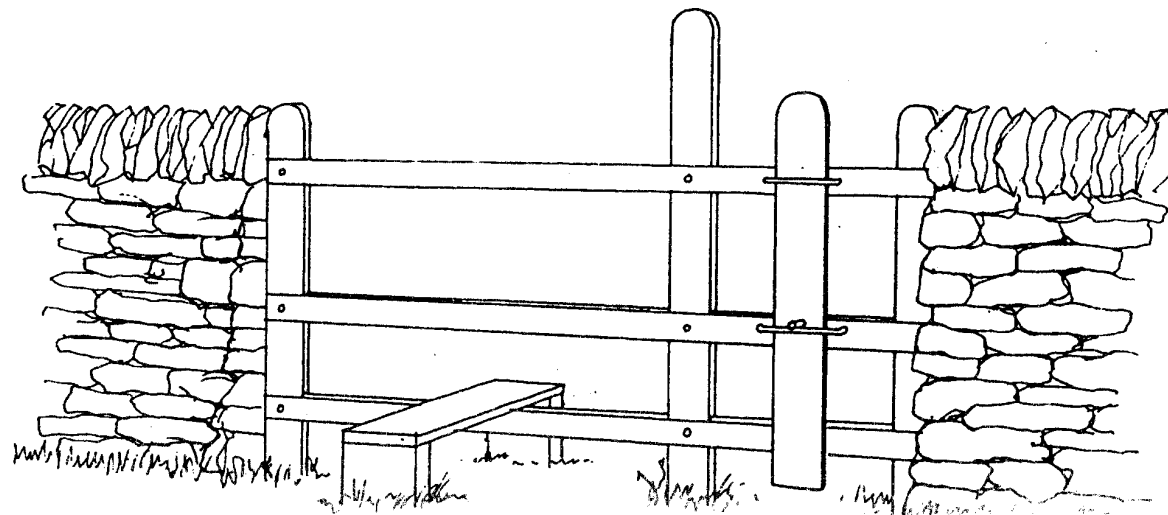
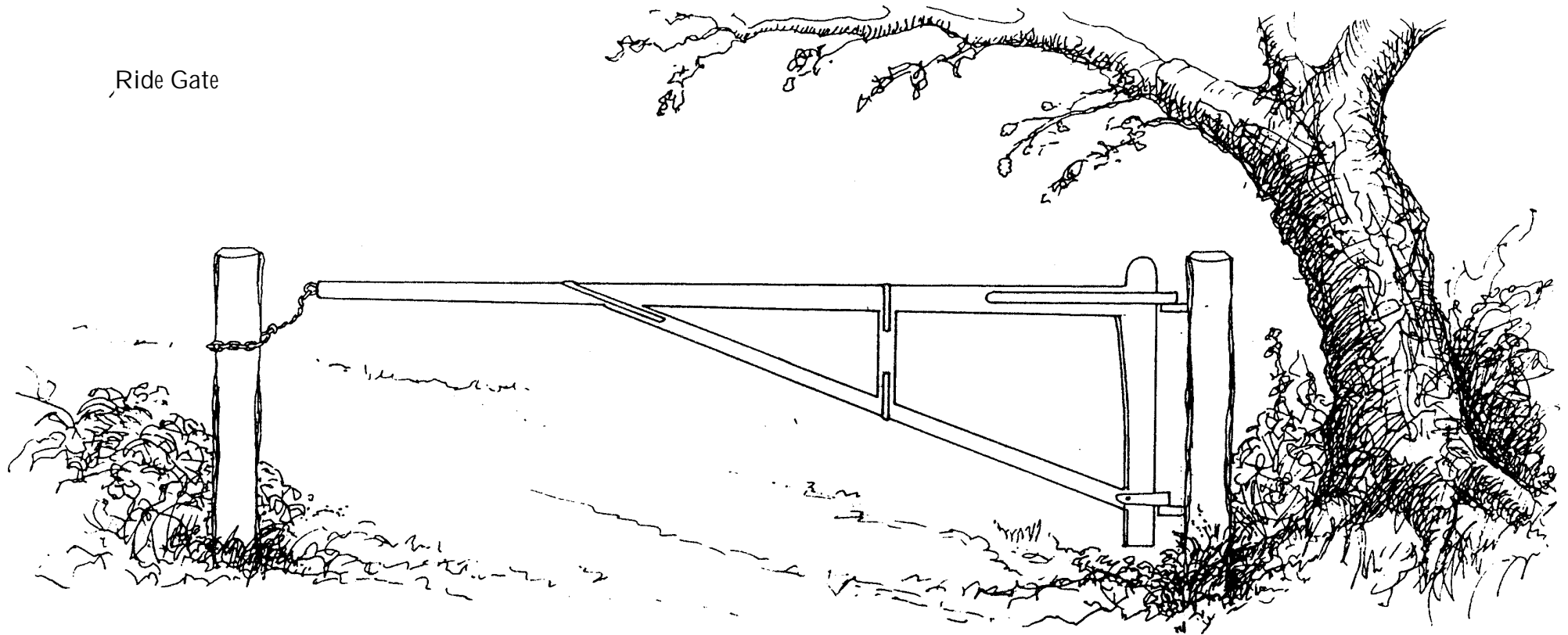

Dog Latch Stile

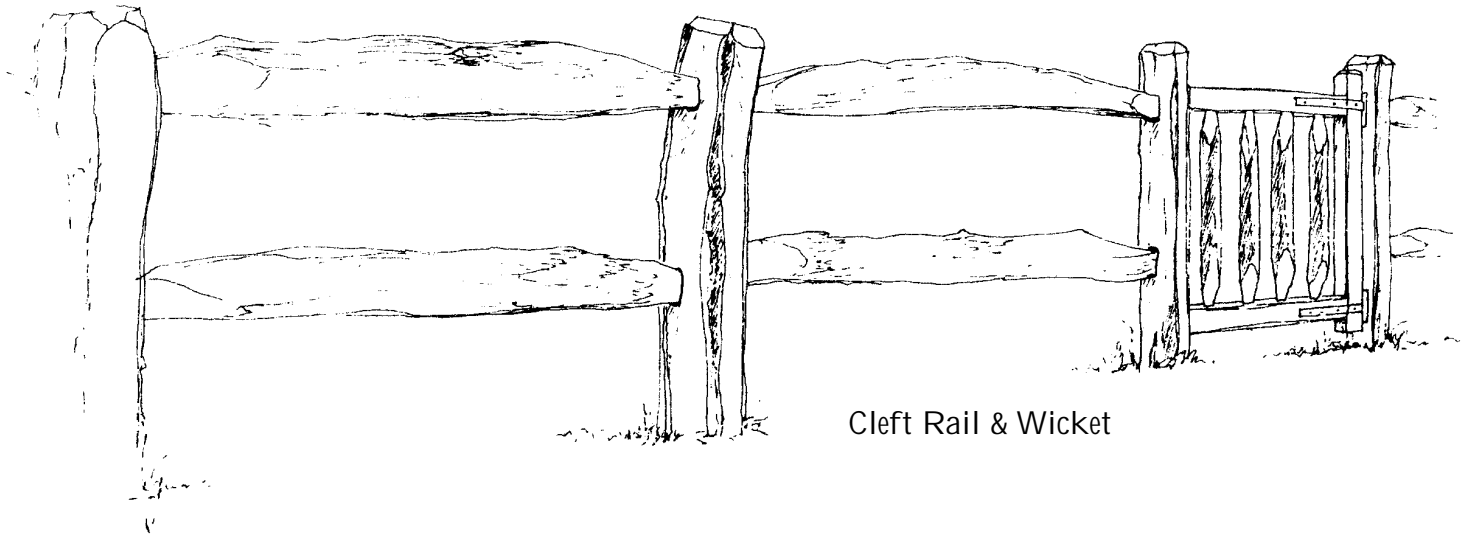

Cleft Rail & Wicket

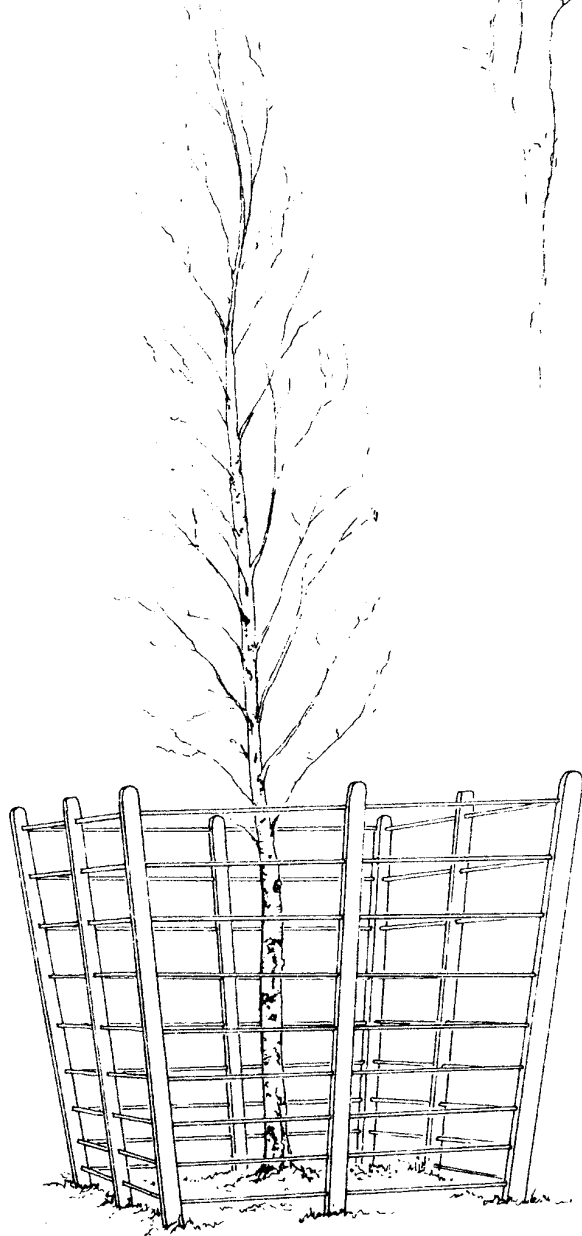

Tree Guard

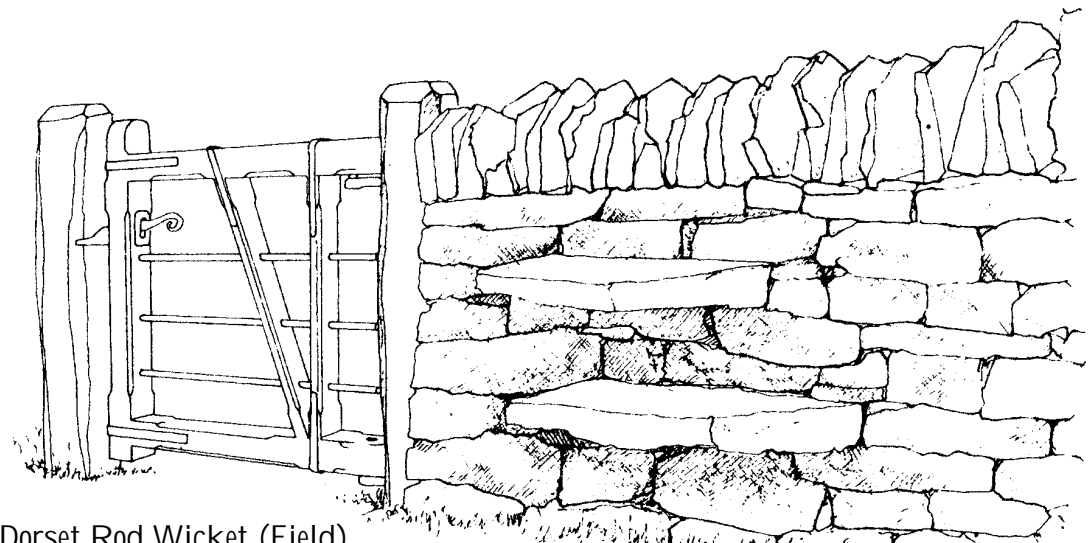

Dorset Rod Wicket (Field)

Stile Steps in Dry Stone Wall

N. Entwistle Feb. 94

Winterborne Zelston Fencing Ltd.

Tel. 01929 459245

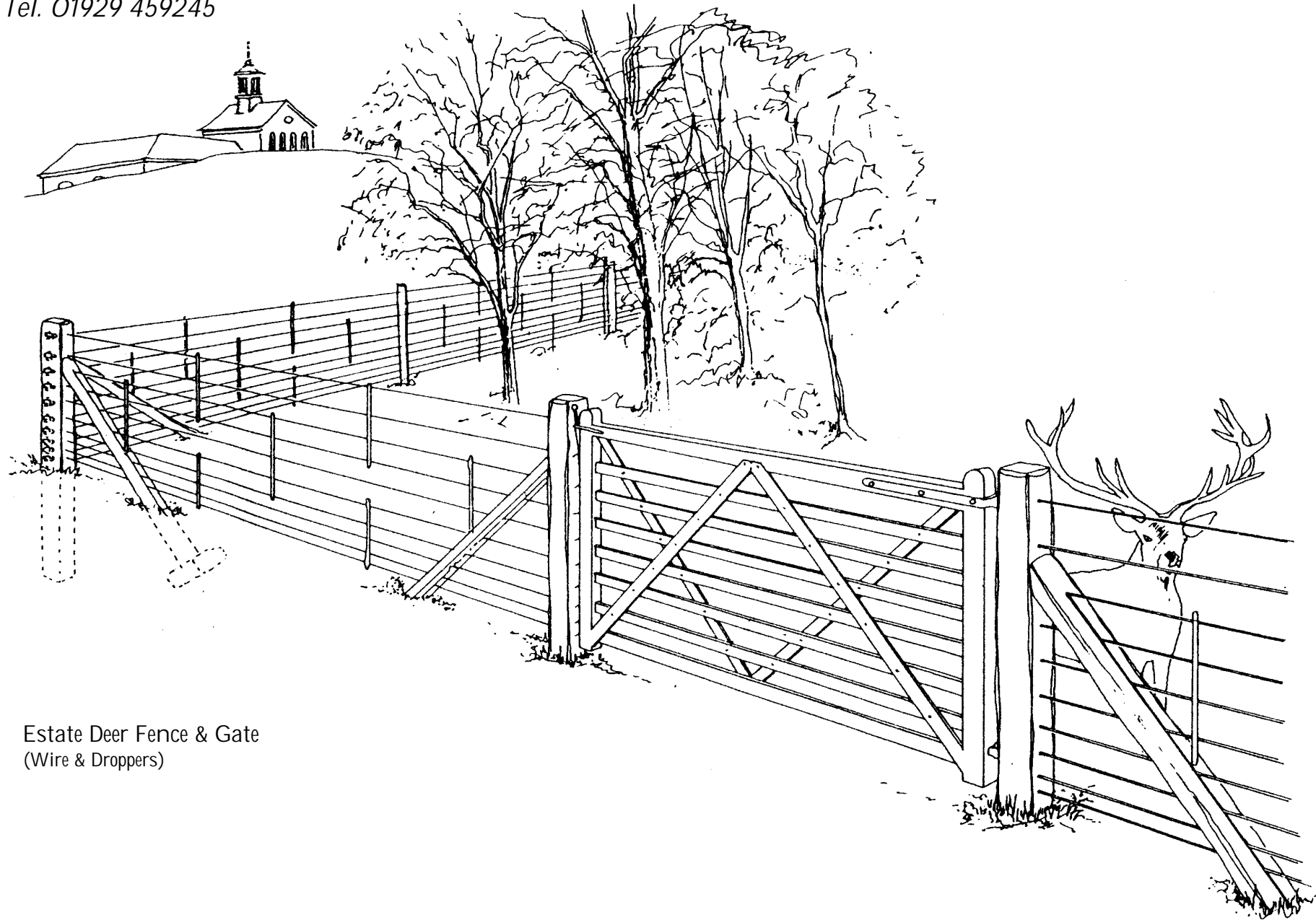

Estate Deer Fence & Gate
(Wire & Droppers)

M Newbold 1995

Winterborne Zelston Fencing Ltd.

Tel. 01929 459245

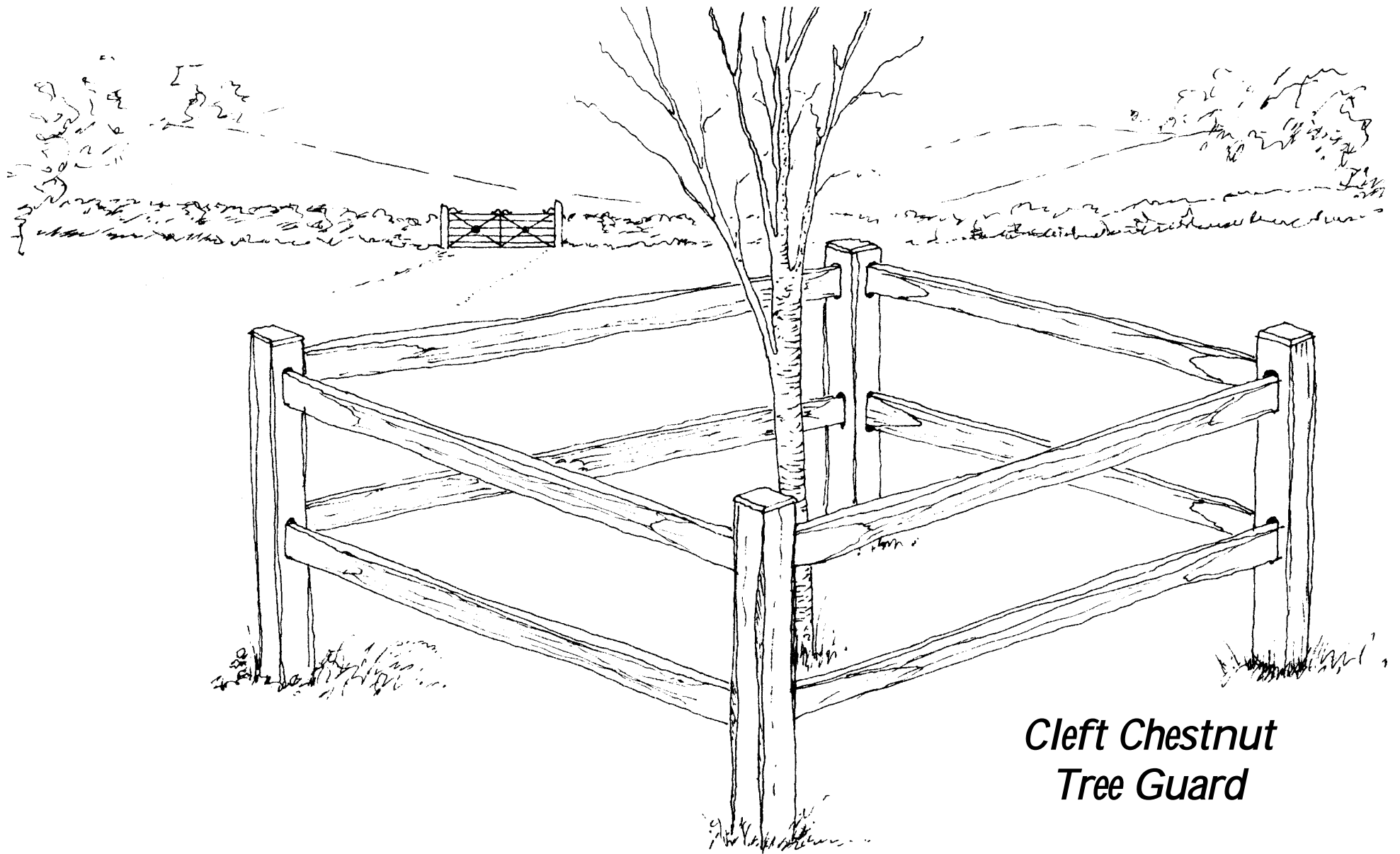

**Cleft Chestnut
Tree Guard**

Square Sawn Post & Rails

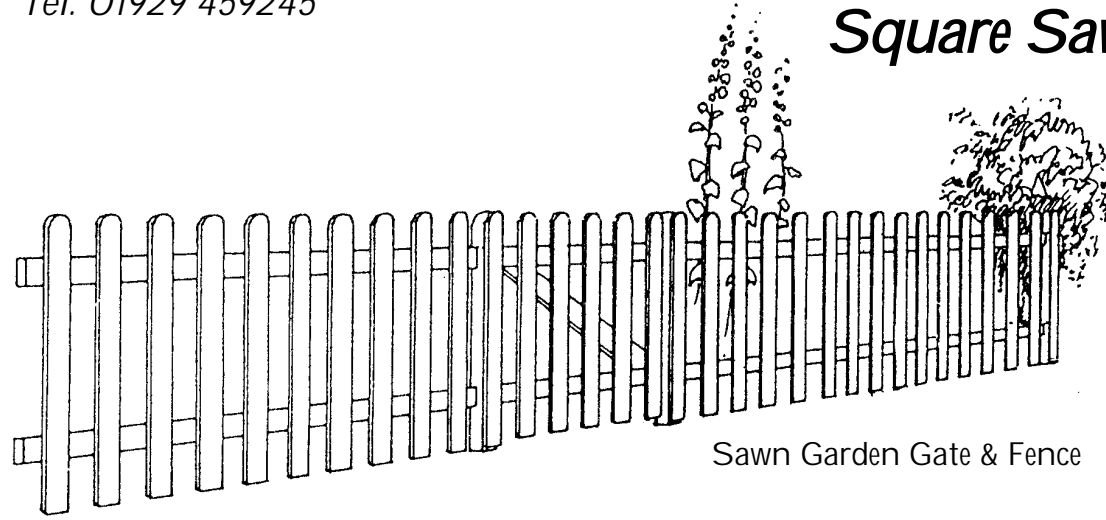

Sawn Garden Gate & Fence

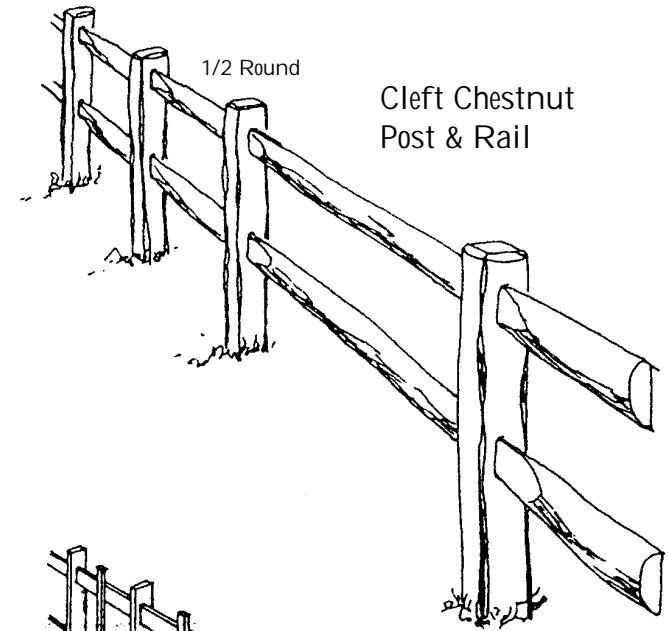

Cleft Chestnut
Post & Rail

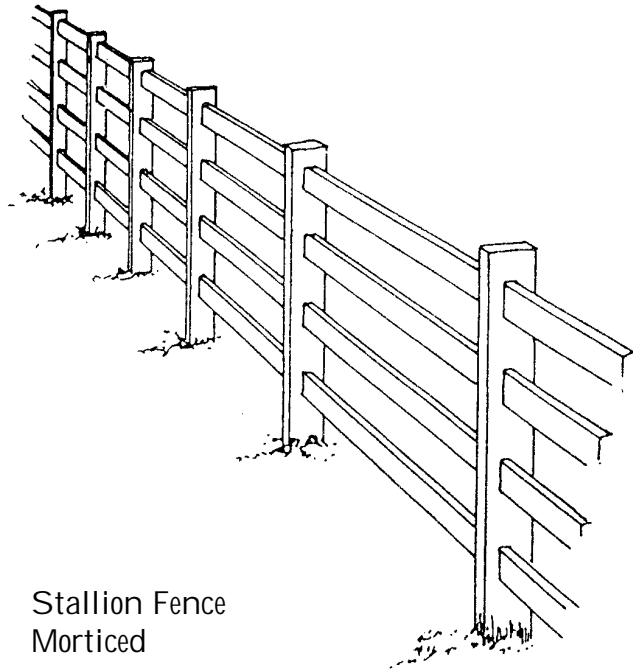

Stallion Fence
Morticed

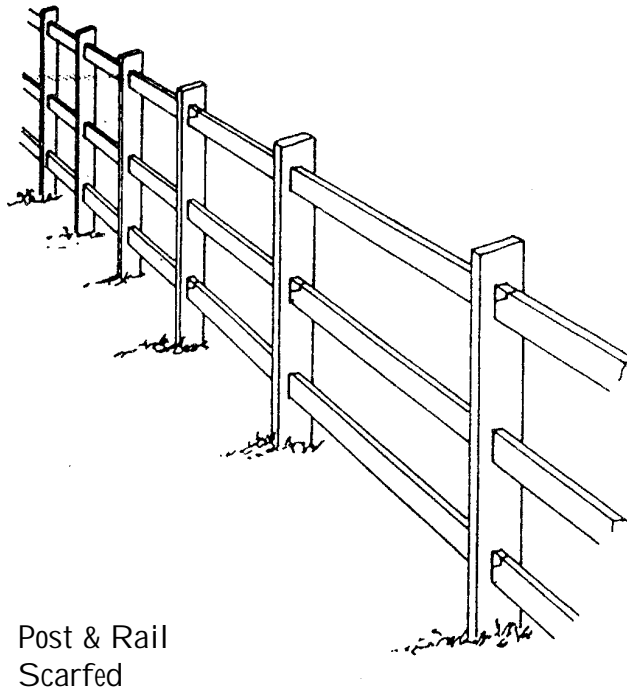

Post & Rail
Scarfed

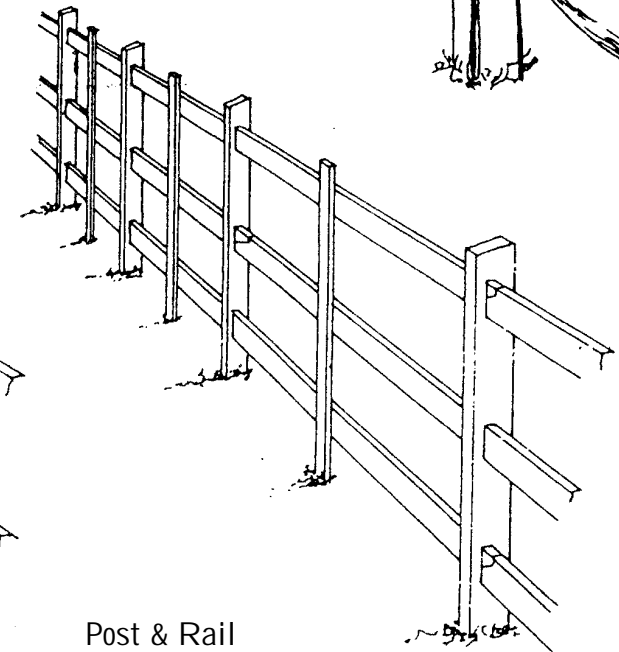

Post & Rail
with Prick & Post

Mil / enium Gates

Memorial or
Church Gate

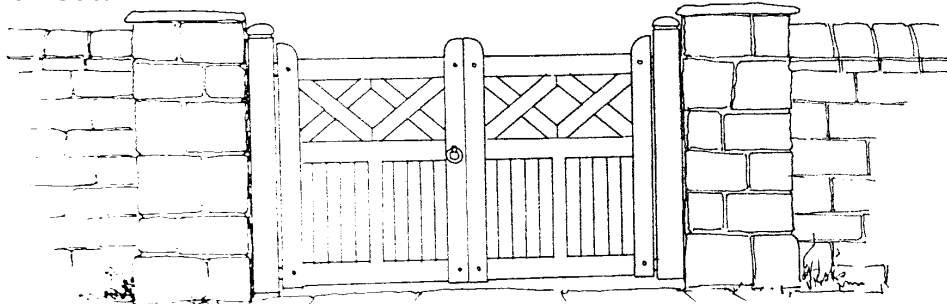

Elizabethan Gate with Closeboard Fencing and Side Gate

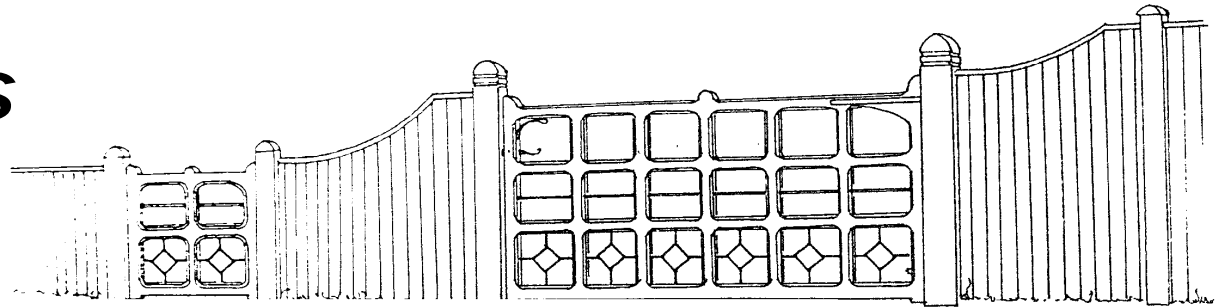

Tudor Arch
Gates

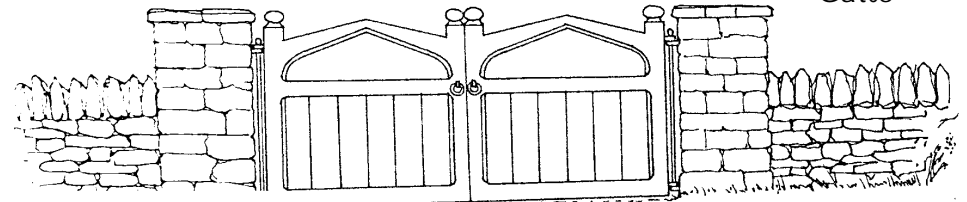

Dorset Rod Gate (Field)

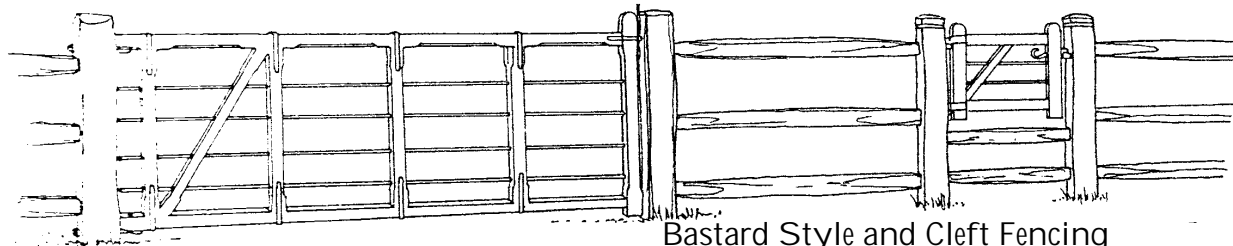

Bastard Style and Cleft Fencing

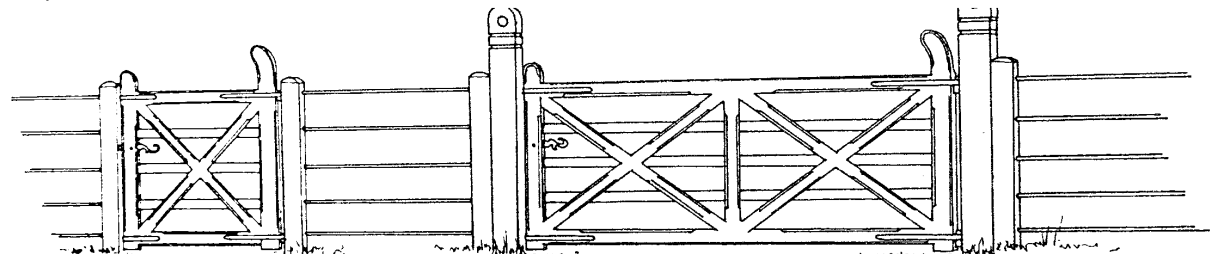

Mini Meran Gate

Post & Rod Fencing and Meran Gate

Hardwood Estate Fencing

The World of Cleft

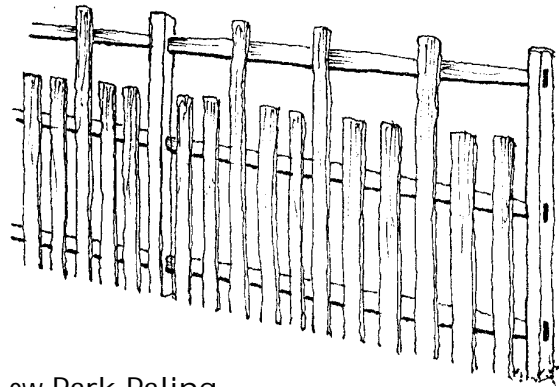

Low Park Paling

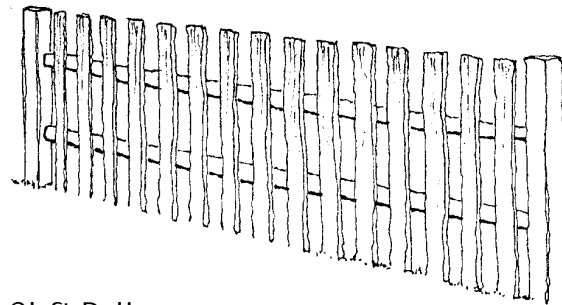

Cleft Paling

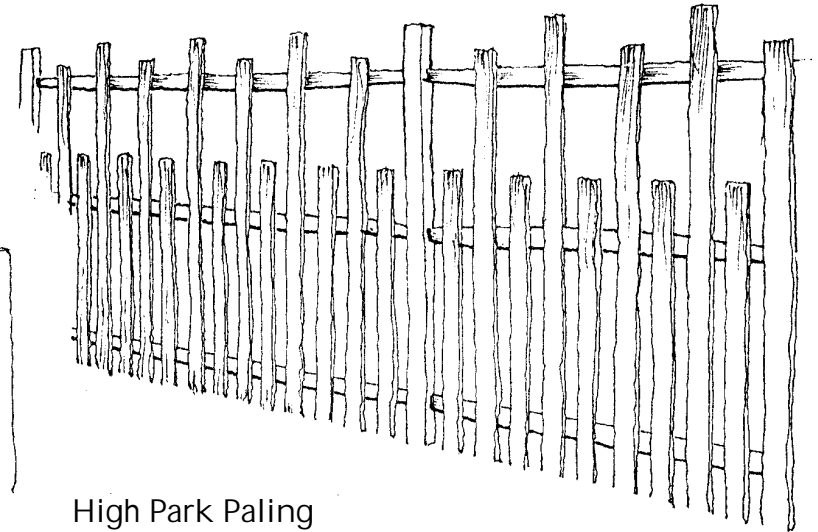

High Park Paling

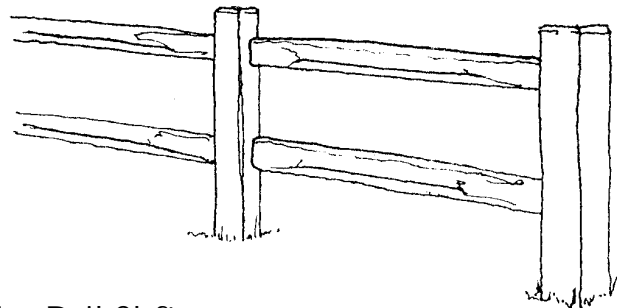

Two Rail Cleft

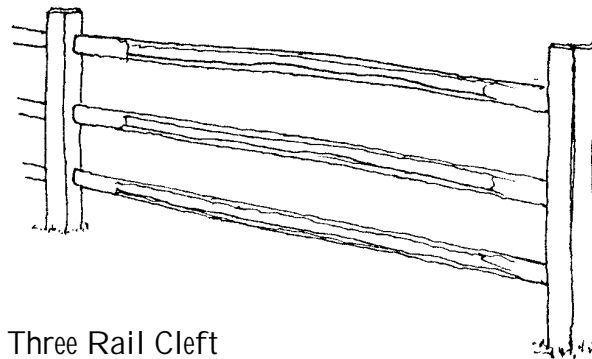

Three Rail Cleft

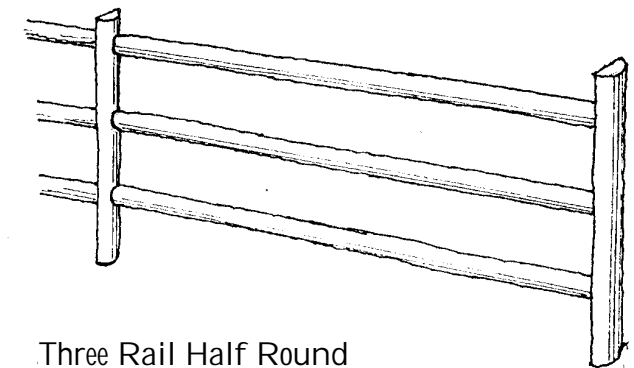

Three Rail Half Round

Mil I enium Gates

Edwardian Estate Entrance

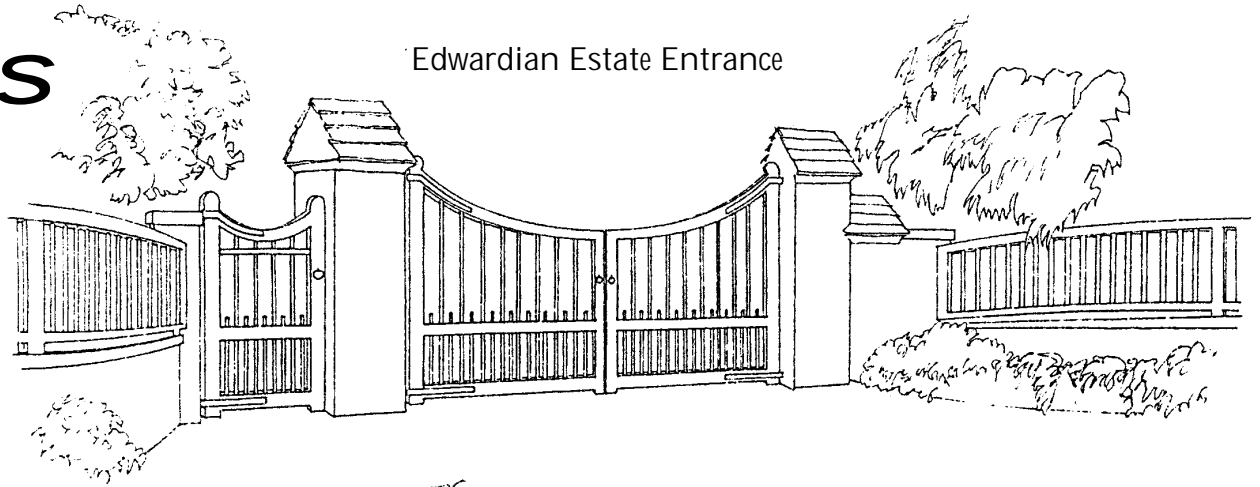

Elizabethan Gates and Paling Fence

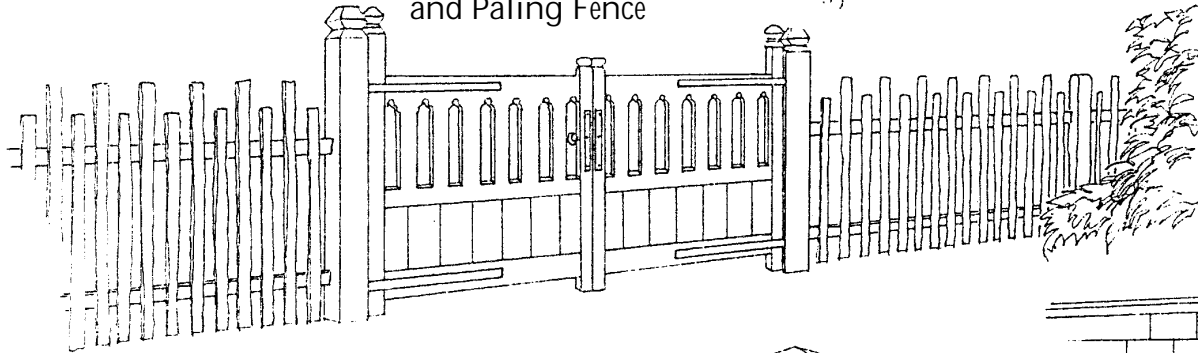

Tudor Gates

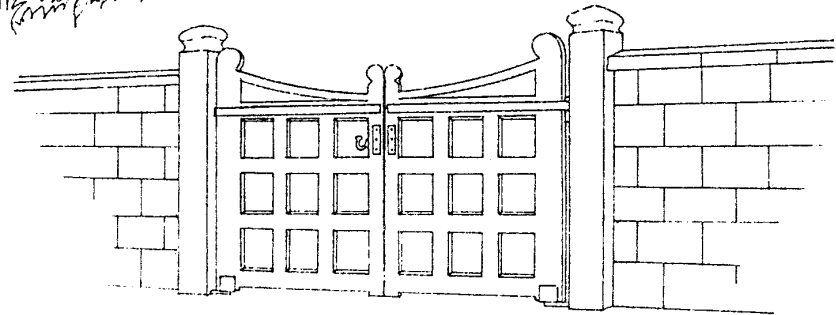

Tudor Gates & Wicket

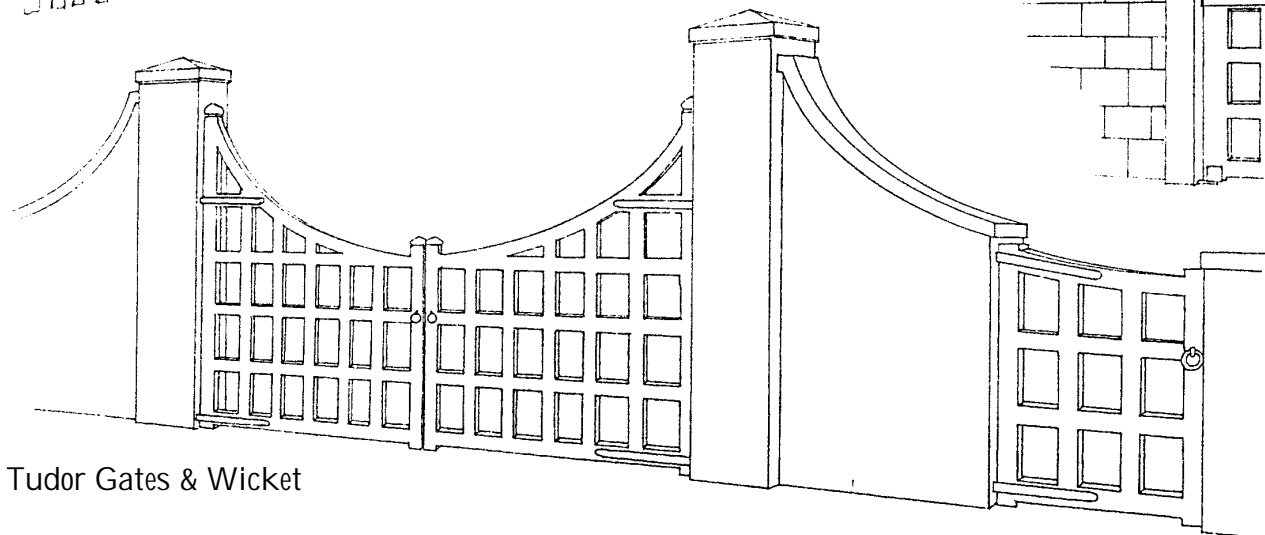

Mil / enium Gates

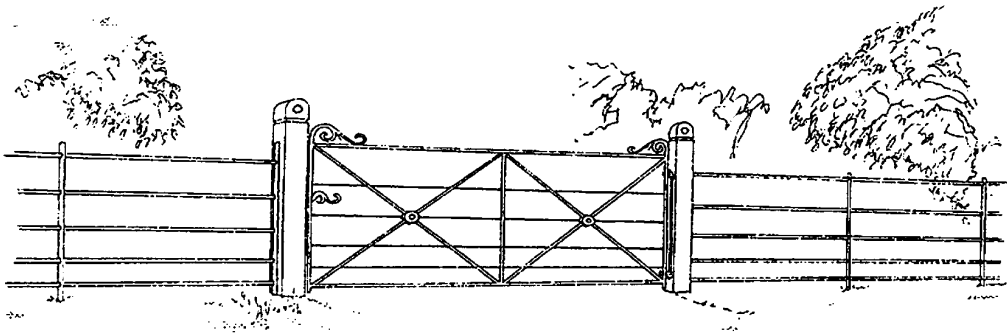

Sarsden Field Gate

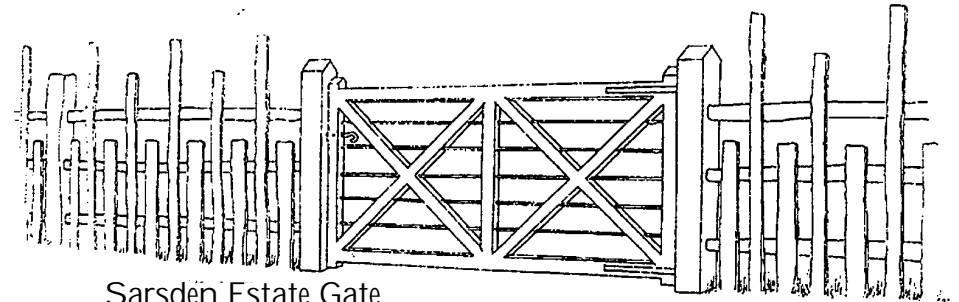

Sarsden Estate Gate
& Deer Park Paling Fence

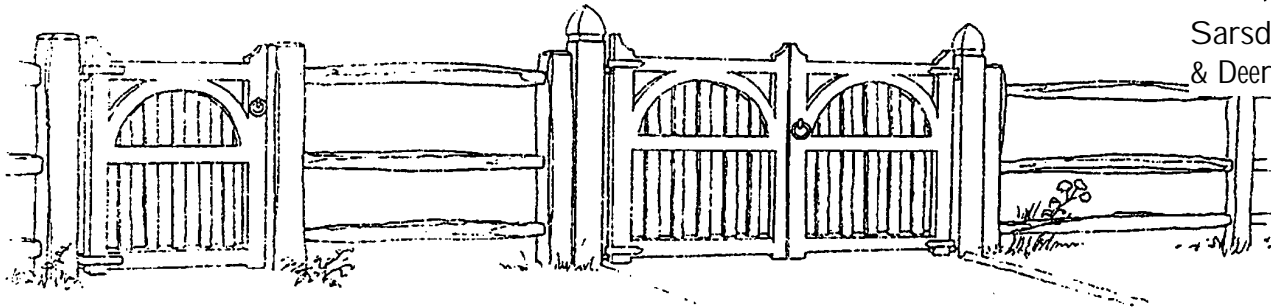

Cleft Hoop Gates

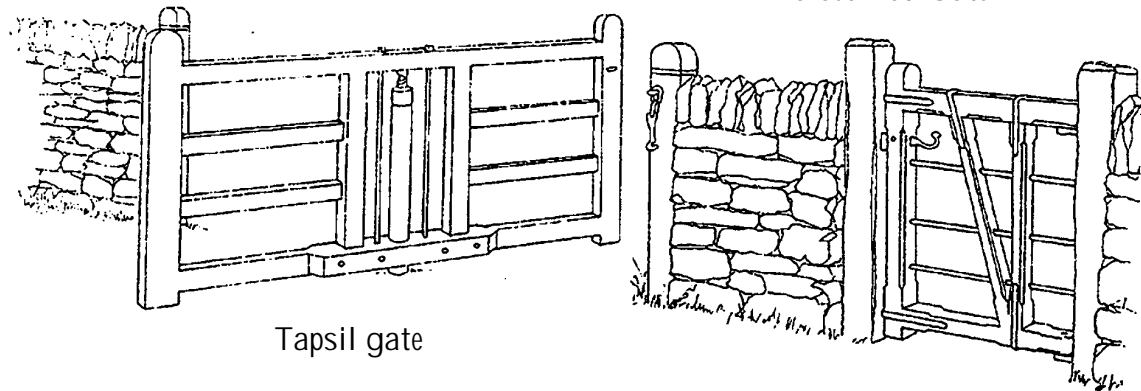

Tapsil gate

Dorset Rod Gate

The World of Cleft

Classic Tree Guards

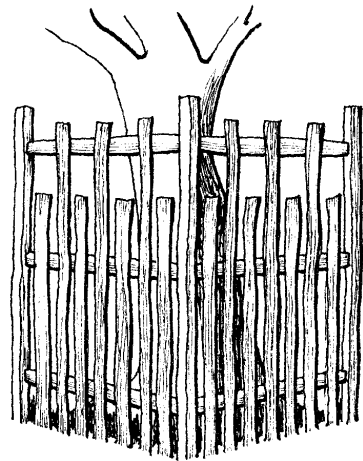

Cleft Park Paling

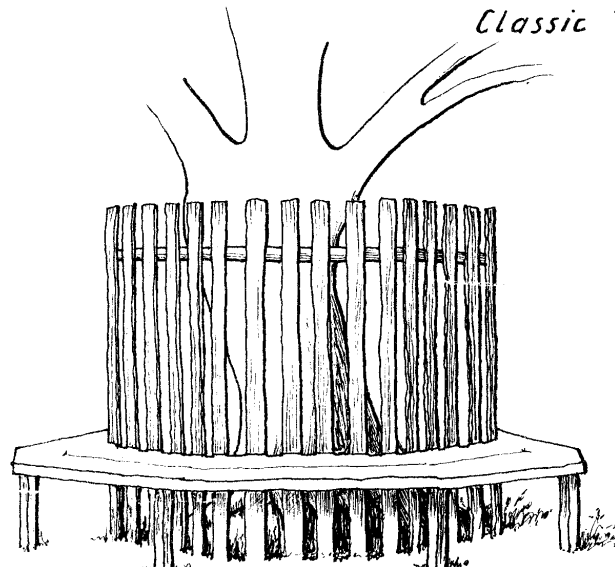

Cleft & Board 18°C Seat

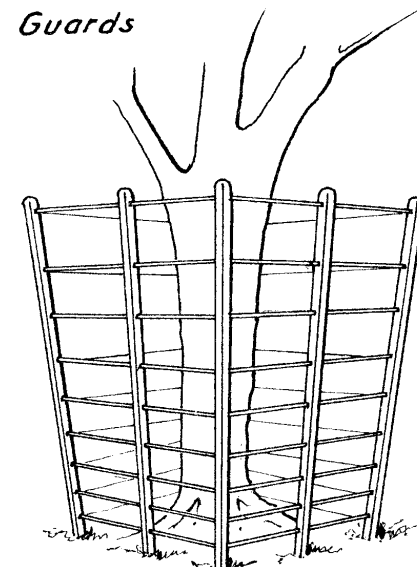

Formal Large Post & Rail

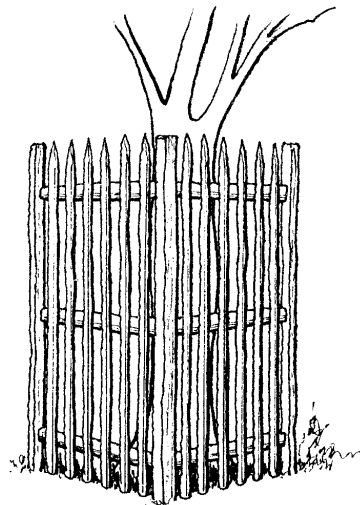

Half Round Paling

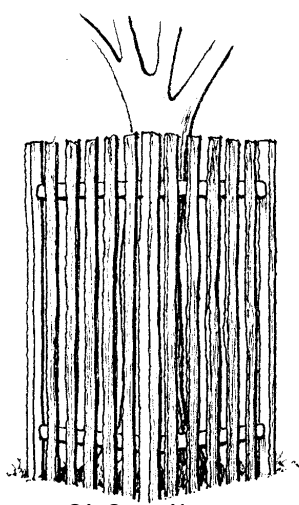

Cleft paling

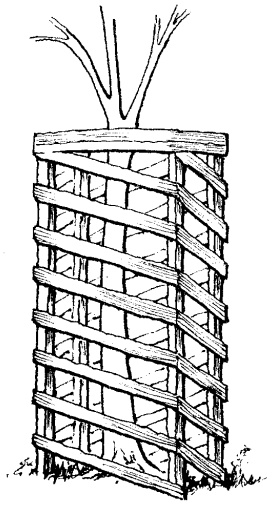

Cleft Zig-Zag

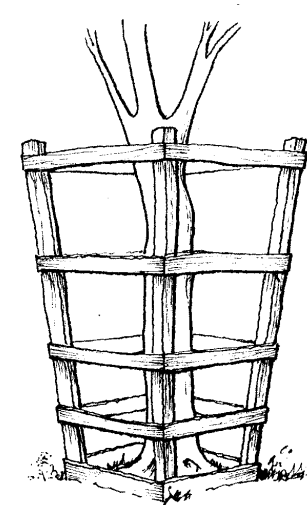

Cleft Pyramid

Mil / enium Gates

Victorian Gate

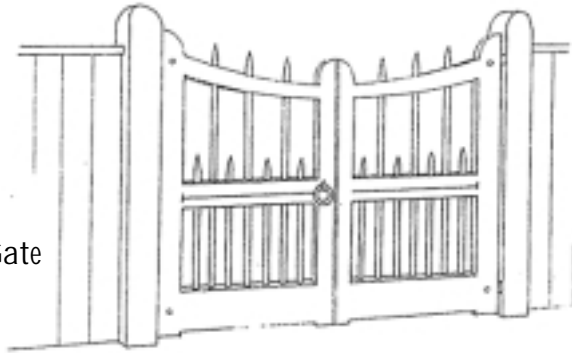

Hoop & Bar Gate

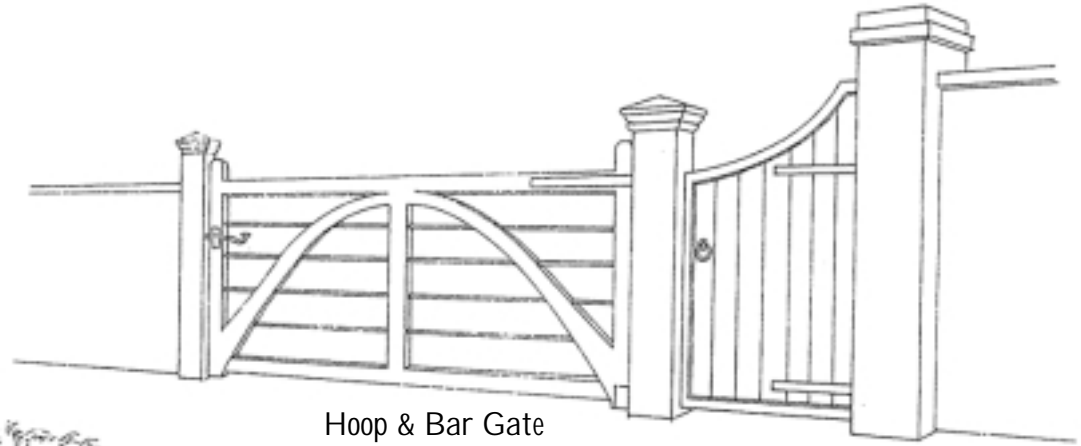

Shepherd Crook Gate

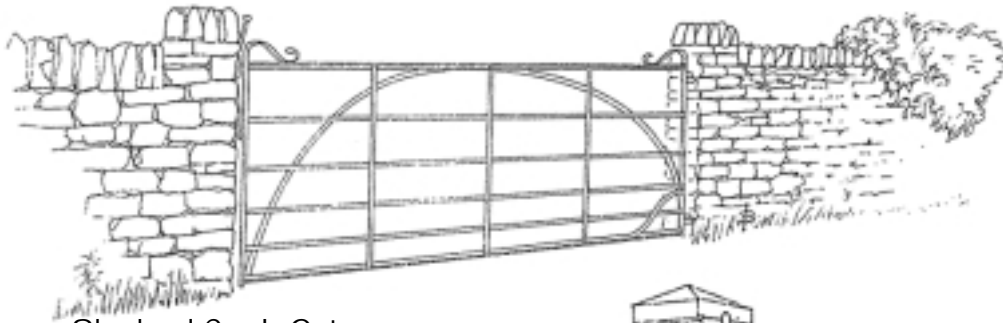

Regency Stable gate

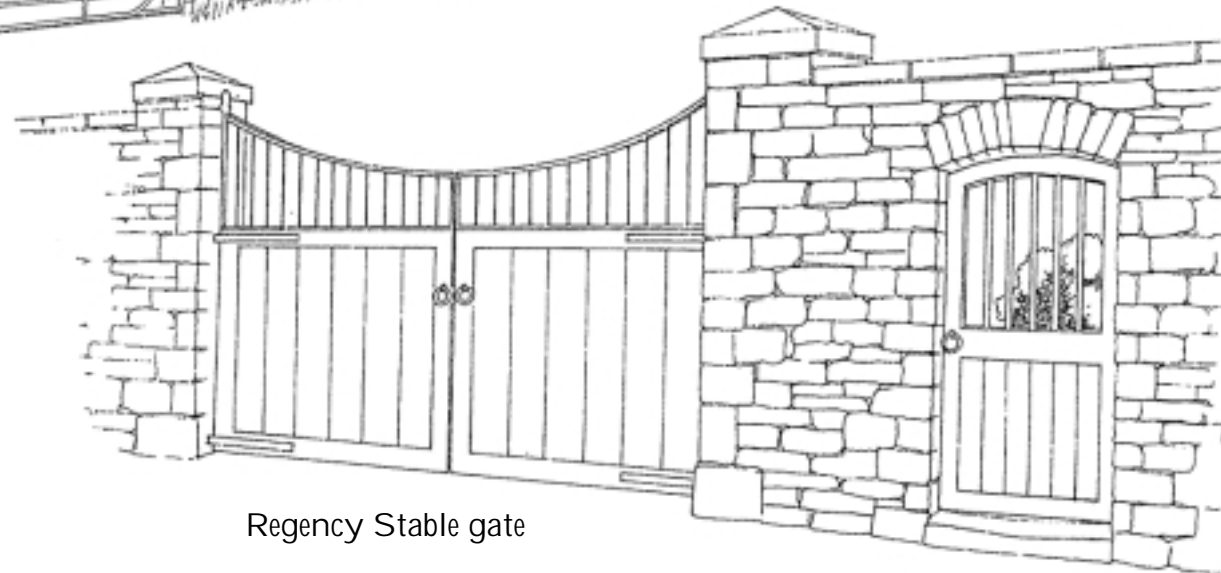

IRON TREE GUARDS

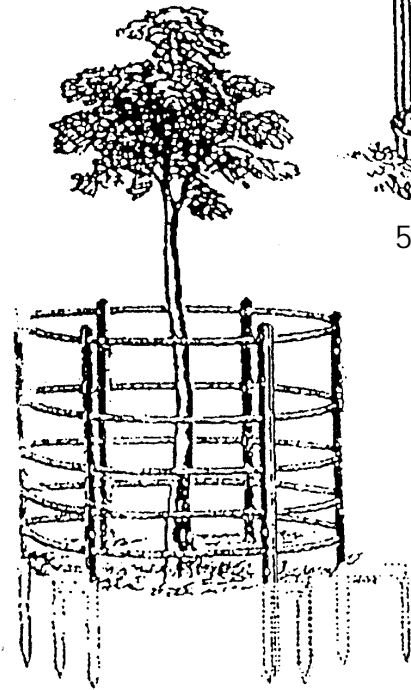

4ft x 4ft or 8ft diameter

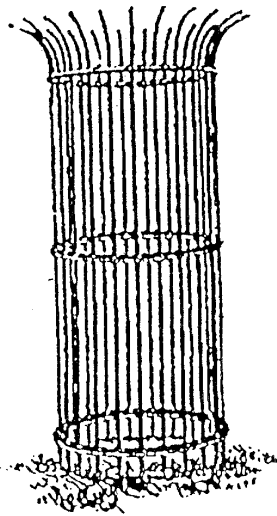

5ft x 2ft 6in diameter

This Guard has three Loose Feet for fixing into ground

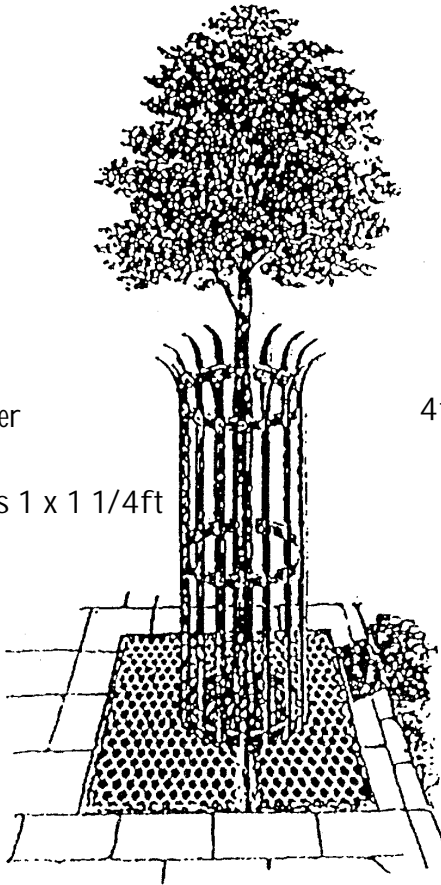

Flat Bars 1 x 1 1/4ft

Grating

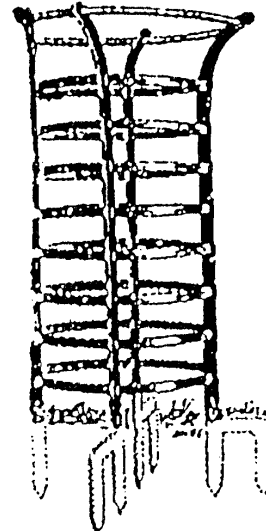

4ft x 2ft 6in diameter

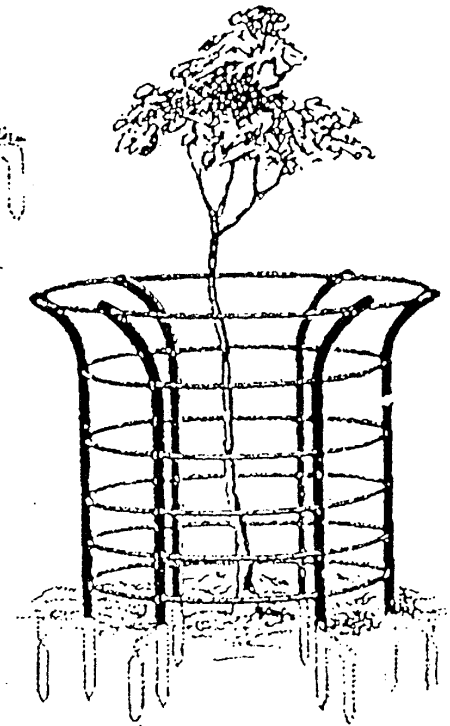

5ft x 5ft diameter

GATEPOST FINIALS

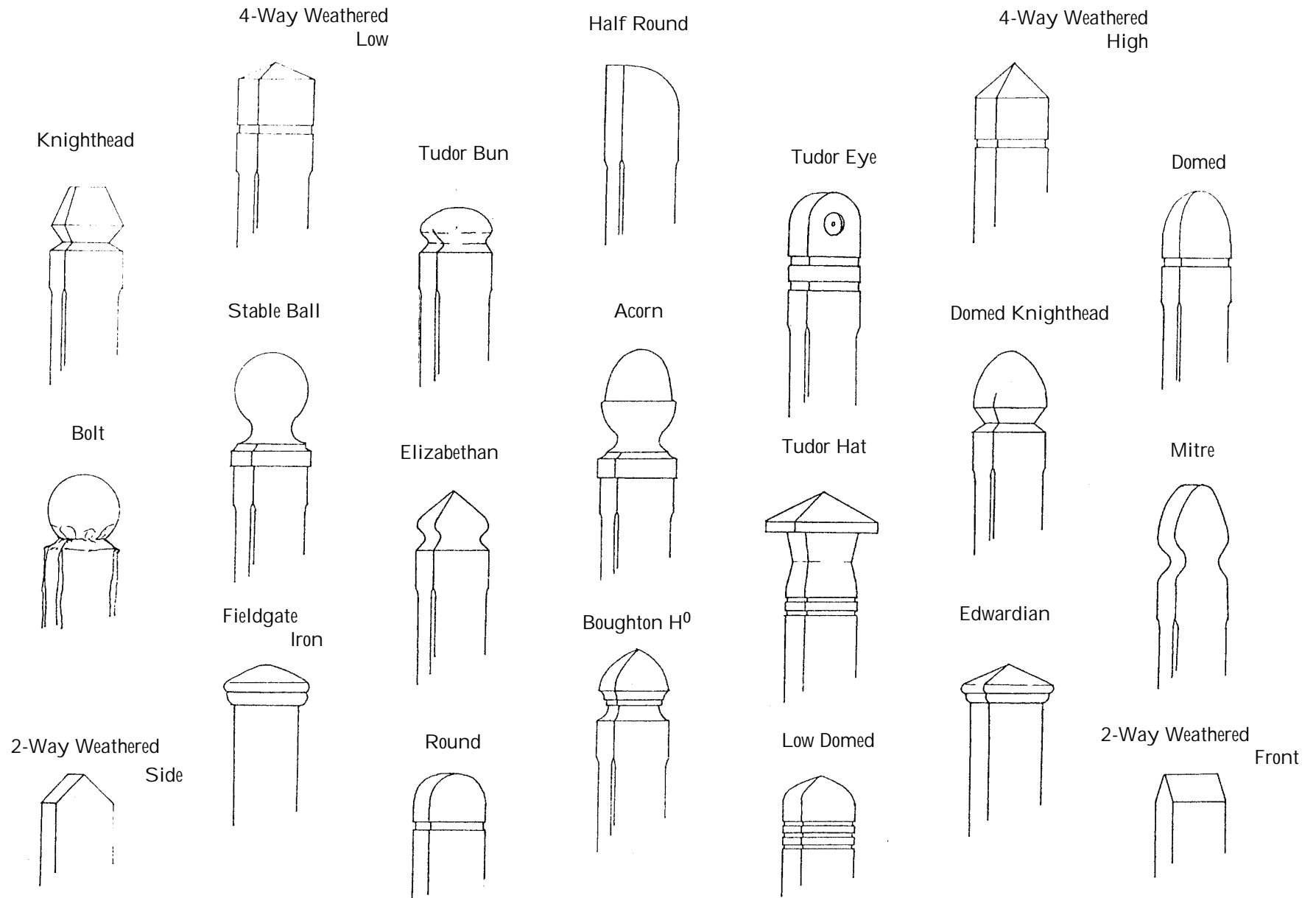

1200mm High Moorland Fencing (Turnover Tops)

3

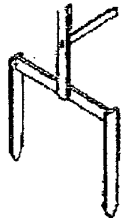
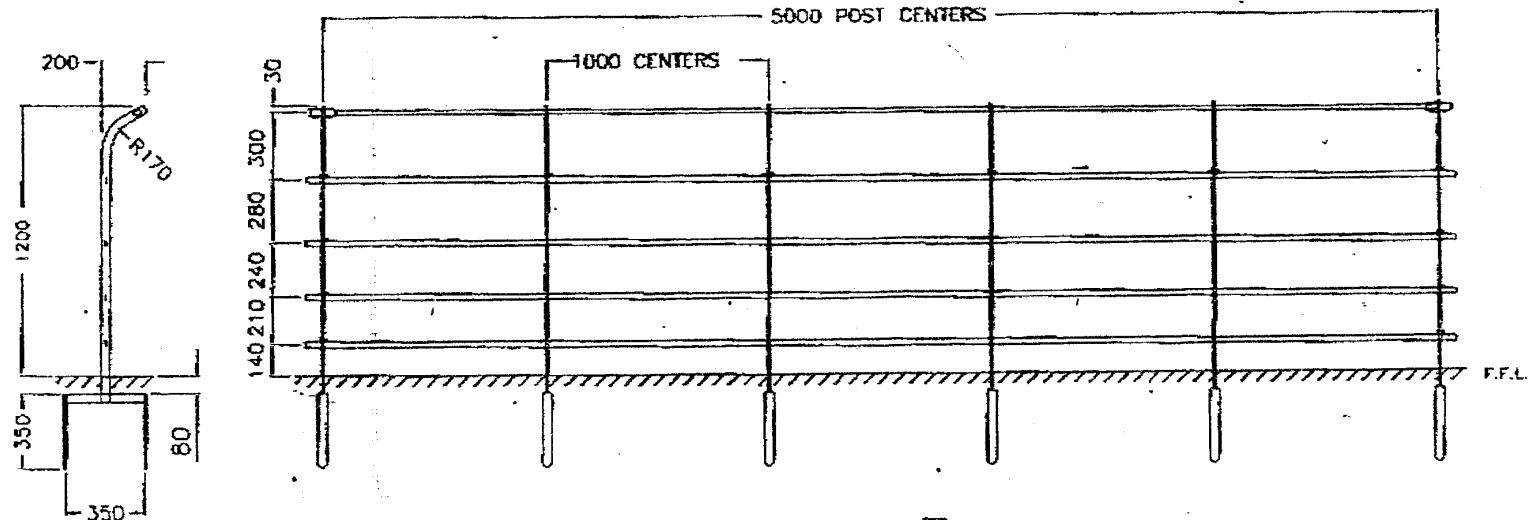

DEVIL'S CLAW

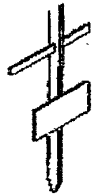

THRUST PLATE

GROUND FIXING
OPTIONS

Rail Fixing Detail

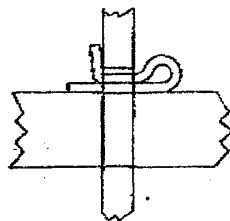

Lower 25x6 RSF Rails
(Joiner Post Only)

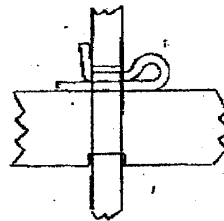

Top 25x6 RSF Rail c/w
Notch Detail (All Posts)

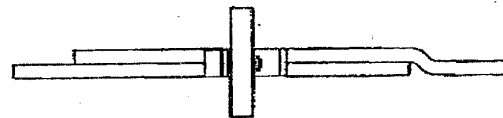

Rail Fixing Detail At Joiner Posts
Showing Kinked End Detail

Title
Traditional Continuous Bar Estate Railing

Specification
Top Rail = Ø20mm Bar
Lower Rails = 25x6 RSF
Joiner Posts = 40x10 RSF
Intermediate Posts = 40x10 RSF

Standard Finish
Hot Dip Galvanised to BS EN ISO 1461

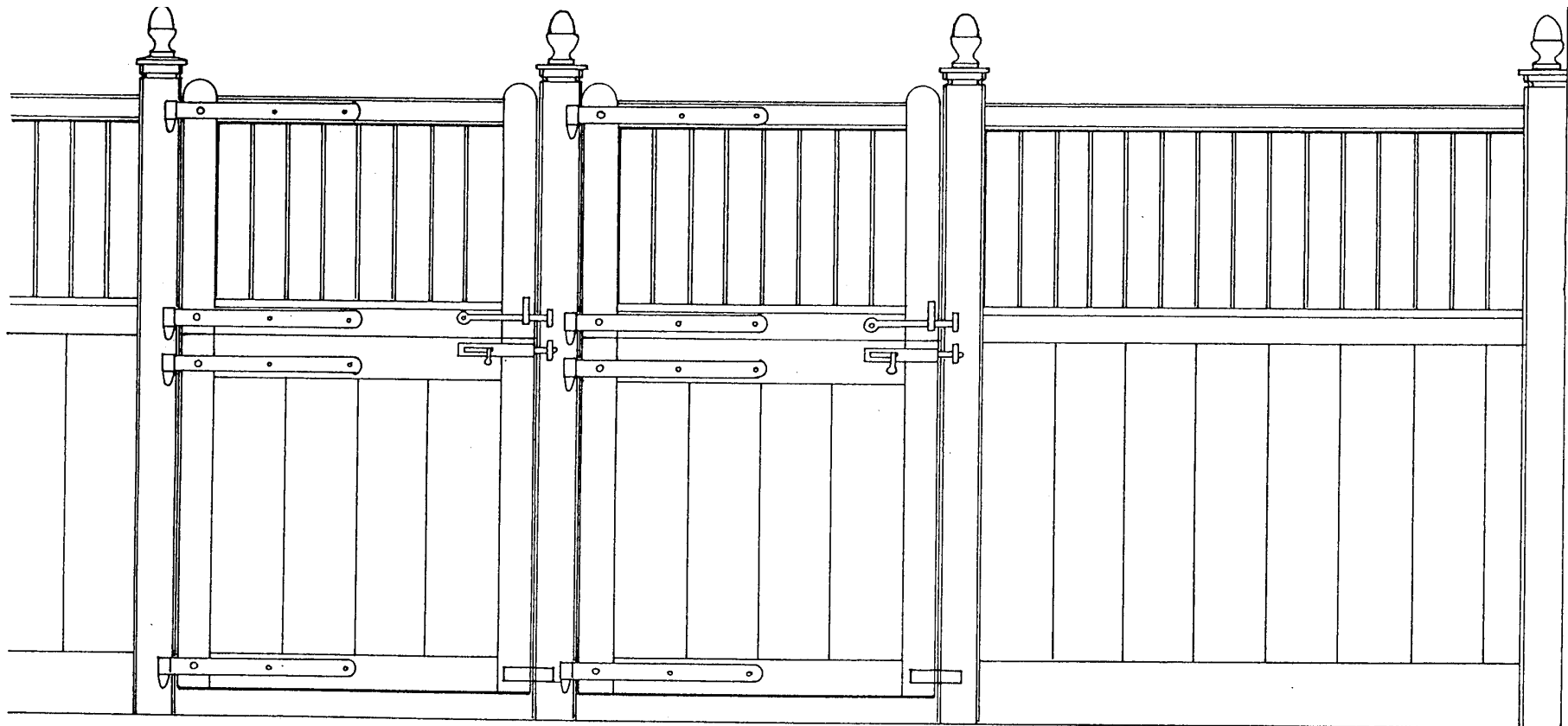

Waverley House
Regency Stables

Herefordshire Gate

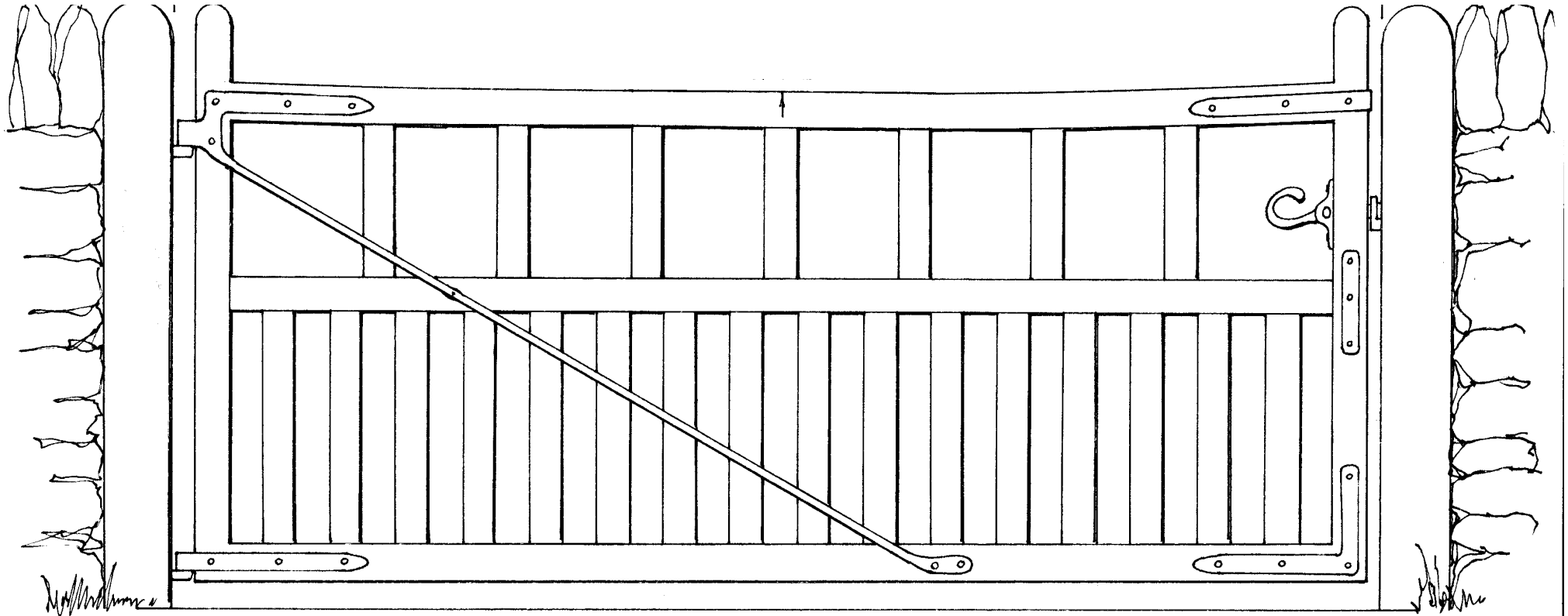

The Heald Gate

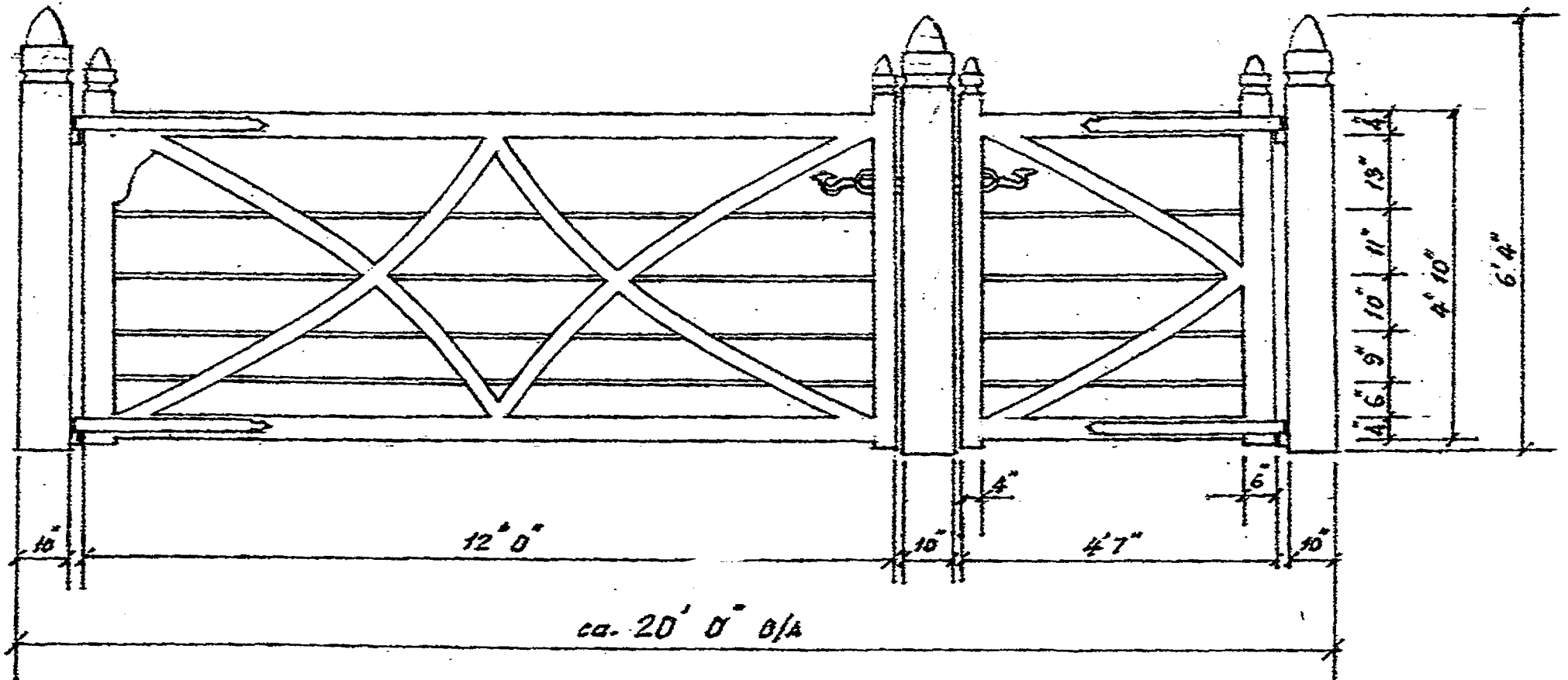

Traditional Estate Railings

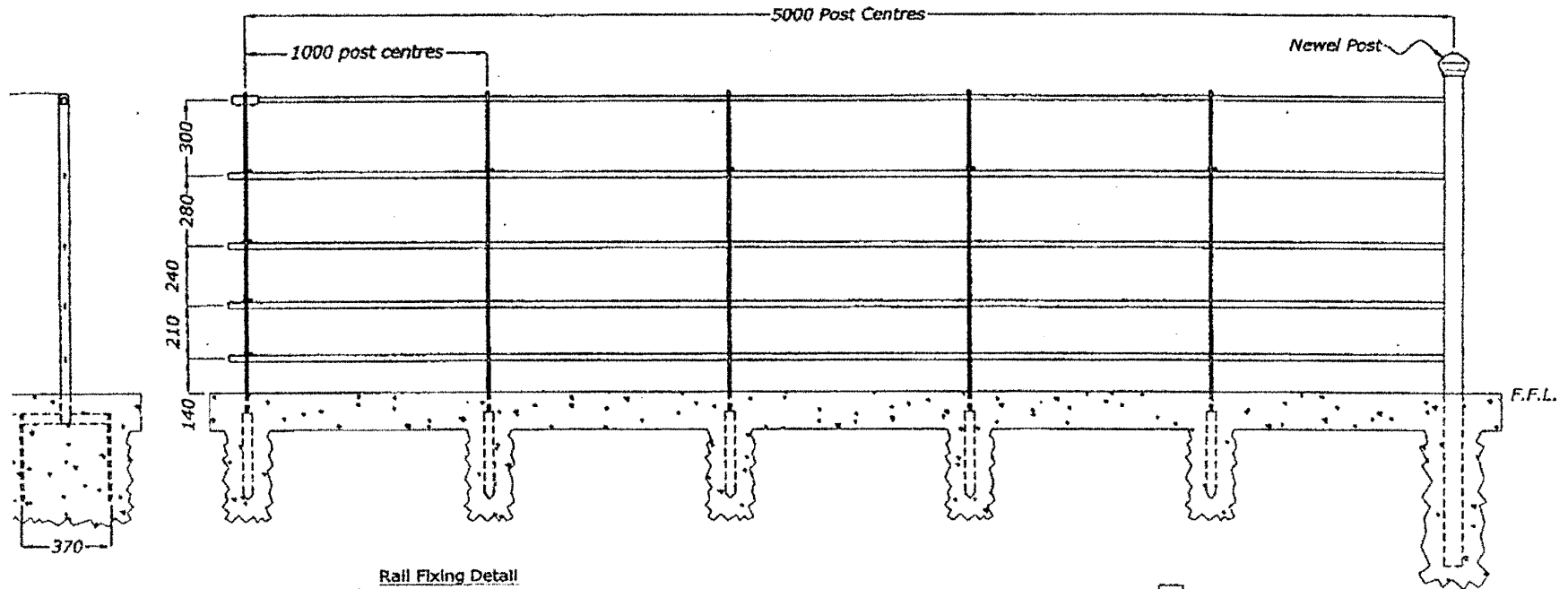

Rail Fixing Detail

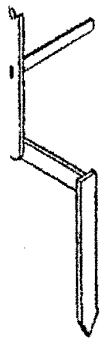

Ground Fixing
Devil's Claw

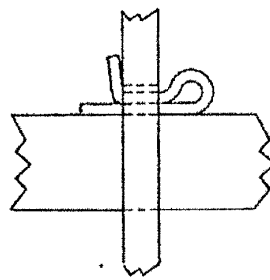

Lower 25x6 RSF Rails
(Joiner Post Only)

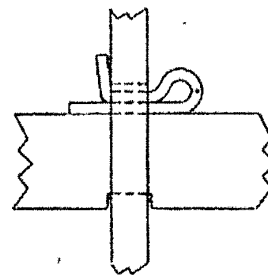

Top 25x6 RSF Rail c/w
Notch Detail (All Posts)

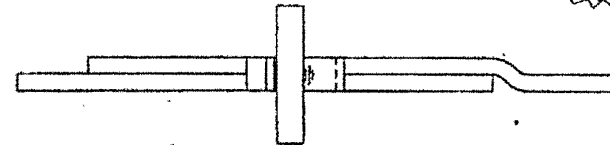

Rail Fixing Detail At Joiner Posts
Showing Kinked End Detail

Title	Traditional Continuous Bar Estate Railing
Specification	1.2m H _g H
	Top Rail = Ø20mm Bar
	Lower Rails = 25x6 RSF
	Joiner Posts = 50x10 RSF
	Intermediate Posts = 40x10 RSF
	End/Newel Posts = Ø76.1x4 CHS
Standard Finish	Hot Dip Galvanised to BS EN ISO 1461

Baddesley Clinton Gate

* NB. Dimensions of Piers and existing Fittings to be most accurately measured on site before cutting any Material.

Baddesley Clinton
Scale $\frac{1}{8}^{\text{th}}$ Full Size.

Pier to Pier

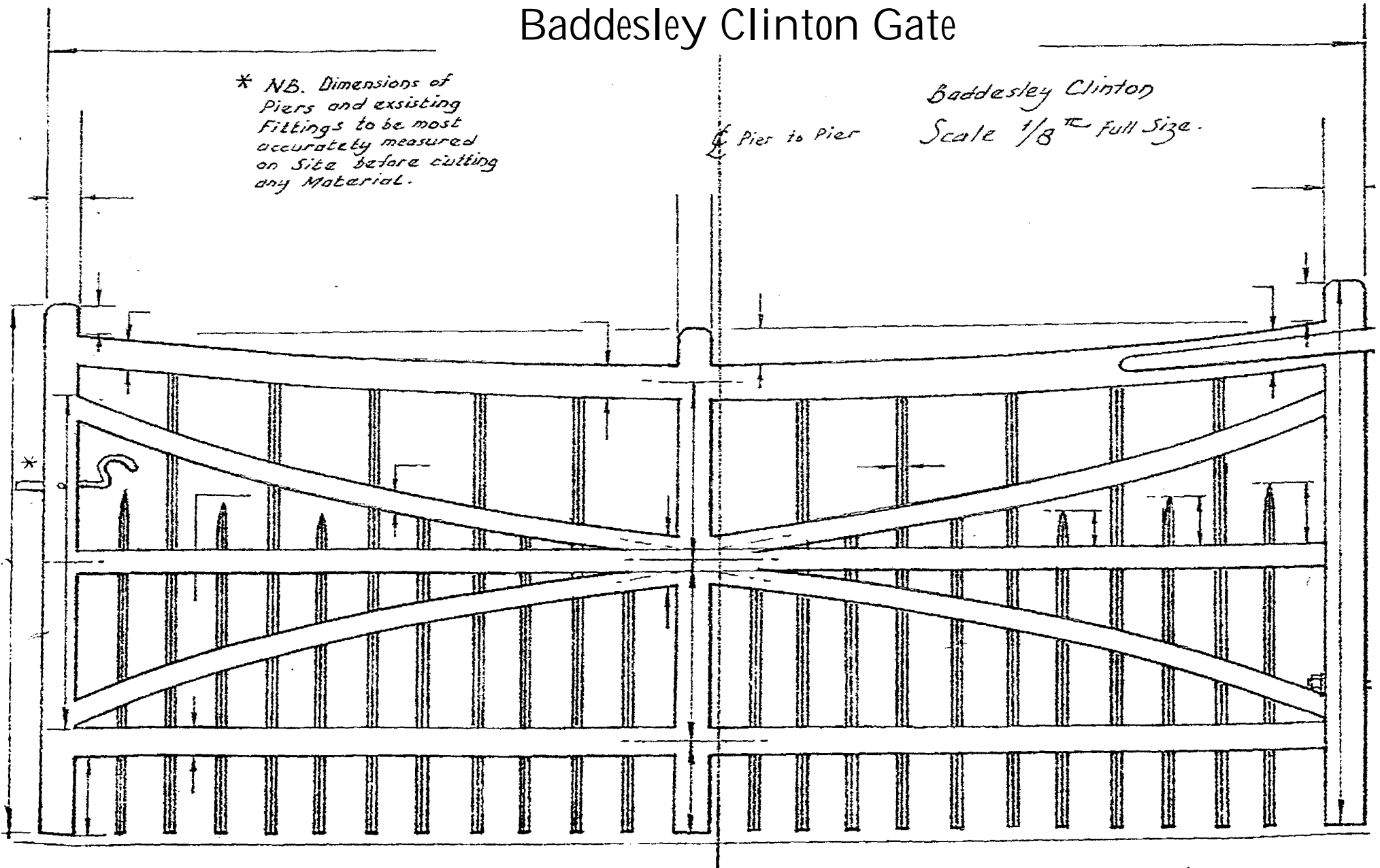

Winterborne Zelston Fencing Ltd.
Tel. 01929 459245





WORLD OF CLEFT

Traditional Fencing Handmade Gates and Stiles

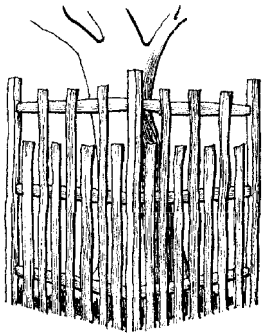

cleft Park Paling

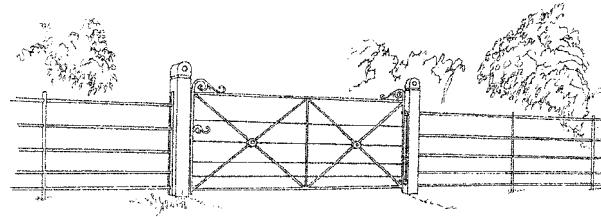

Sarsden Field Gate

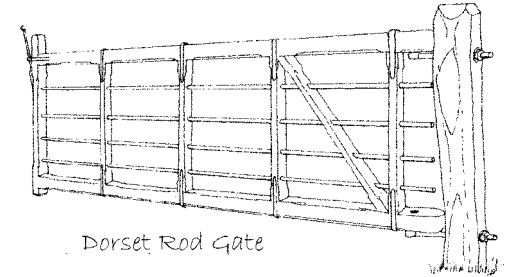

Dorset Rod Gate

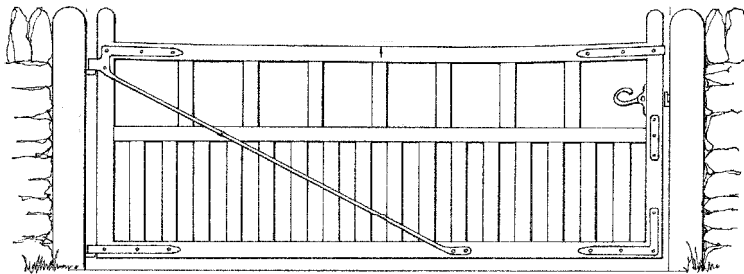

The Herefordshire Gate

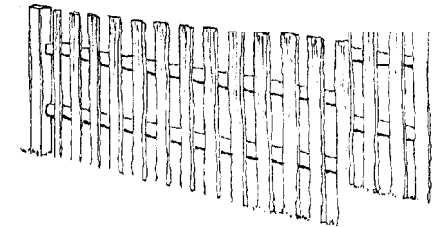

cleft Paling

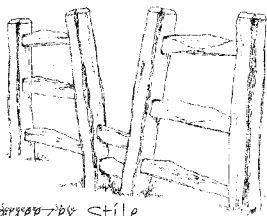

Squeezer Stile

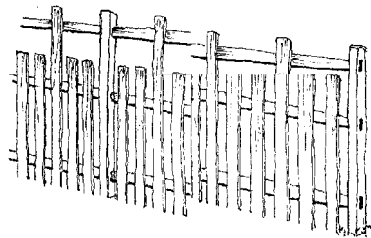

Low Park Paling

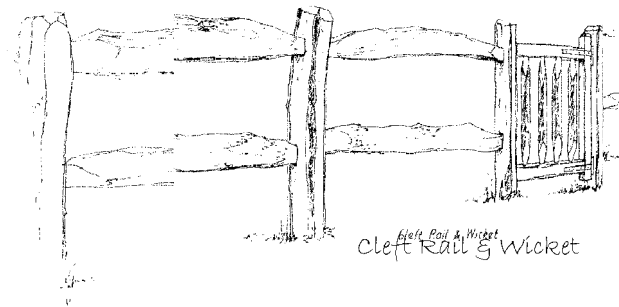

cleft Rail & Wicket

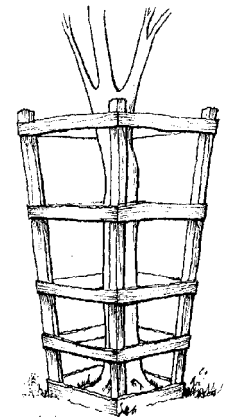

cleft Pyramid

Winterborne Zelston • Blandford Forum • Dorset DT11 9EU
Tel: 01929 459245 • Fax: 01929 459011 • Mobile: 07831 101671
email: richard@winterbornezelstonfencing.co.uk

WORLD OF CLEFT

Traditional Fencing - Handmade Gates and Stiles



The application of traditional country skills for logging, hedge layering dry stone walling and coppicing

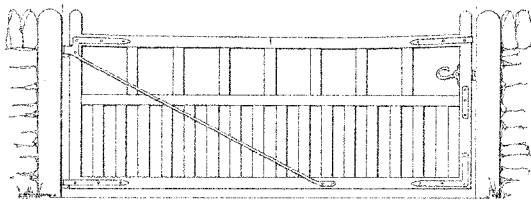

The Herefordshire Gate

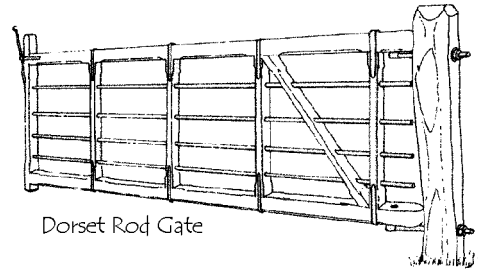

Dorset Rod Gate



Cleft Rail & Wicket

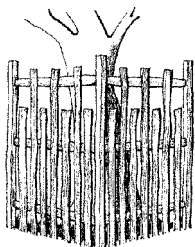

Cleft Park Paling

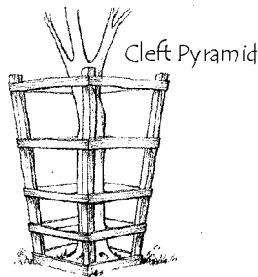

Cleft Pyramid

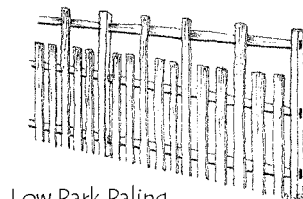

Low Park Paling

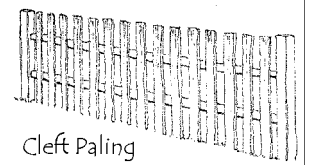

Cleft Paling



Squeezer Stile



Winterborne Zelston ● Blandford Forum
Dorset DT11 9EU

Tel: 01929 459245 ● Fax: 01929 459011 ● Mobile 07831 101671

email: richard@winterbornezelstonfencing.co.uk

Also Cleft Fencing, Iron Fencing and Gates. *Please send for brochure*